



# 2009 HYDROPOOL self-cleaning hot tubs owner's manual



**HYDROPOOL**  
self-cleaning hot tubs

HydroPool Industries:

Tel: 905.565.6810

Toll Free: 1.800.465.2933

Fax: 905.565.6820

Email: [info@hydropoolhottubs.com](mailto:info@hydropoolhottubs.com)

[www.hydropoolhottubs.com](http://www.hydropoolhottubs.com)



99399

# TABLE OF CONTENTS

<b>Letter of introduction</b> .....	3	<b>Jet and Feature Operation</b>	
<b>Important User Safety Instructions</b>		Jet Identification Chart.....	25
Warnings.....	4	Flow Adjustment.....	25
Hyperthermia.....	4	Removal and Replacement.....	26
<b>Choosing the Right location</b>		Diverter Valve.....	26
Indoor Locations.....	5	Waterfall Control (optional).....	26
Outdoor Locations.....	5	<b>Hydropool Surround Sound Audio and</b>	
<b>General Installation Considerations</b> .....	6	<b>Audio/Video Systems Section (optional)</b> .....	27
<b>Special Considerations</b>		<b>Hot Tub Water Balance</b>	
Indoor Installations.....	6	General Overview.....	44
Outdoor Installations.....	6	Initial Fill.....	44
<b>Site Preparation</b>		Glossary of Common Water Maintenance Terms.....	45
Above Ground Installations.....	7	Water Balance Summary for your Hot Tub (chart).....	45
In-ground & Partial In-ground Installations.....	7	Water Balance Troubleshooting.....	46
Overall Support.....	7	Corona Discharge Ozone Technology.....	47
<b>Leveling your Hydropool Hot Tub</b> .....	7	<b>Routine Hot Tub Maintenance</b>	
<b>Equipment Accessibility &amp; Protection</b> .....	8	Daily, Weekly, Monthly, Quarterly.....	47
<b>Remote Equipment Placement</b> .....	8	Cleaning the Skimmer Basket.....	47
<b>Unloading/Handling your Hot Tub</b> .....	8	Cartridge Filter, Removal, Cleaning, Re-installation.....	48
<b>Important Electrical Safety Instructions</b> .....	9	Cleaning the Acrylic Surface.....	48
G.F.C.I./R.C.D. Application Guideline & Wire Size.....	9	Safety Hard Cover.....	48
North America G.F.C.I. Installation Diagrams.....	10	Changing your Hot Tub Water.....	49
Europe R.C.D. Installation Diagram.....	11	Draining your Hot Tub Water.....	49
<b>Accessories</b>		<b>Hydropool Exclusive Quick-Drain™ &amp; Fill (diagram)</b> .....	50
Pillows.....	12	<b>Wood Products</b>	
Filter/Ice Bucket Lids.....	13	Cabinet Wing-Locks.....	51
LED Mood Lighting.....	13	Protecting your Cabinet Wood Finish.....	51
Safety Hardcover Locks.....	13	Gazebos.....	51
Cover Remover (optional).....	13	<b>Winterizing your Hydropool Hot Tub</b> .....	52
<b>Filling, Checking and Starting your Hot Tub</b> .....	14	<b>General Troubleshooting</b> .....	53
Pump Priming/Releasing an Air Lock.....	14	<b>What to do in the event of</b>	
<b>Hydropool Control Systems</b>		Power Fluctuations.....	54
<b>North America</b>		Cold Weather Power Failure.....	54
Silver & Gold Series.....	16		
Platinum & Titanium Series/Limited & Luxury Edition.....	19		
<b>Topside Control Panel Display Messages</b> .....	23		

On behalf of everyone at the company, we thank you for your decision to purchase a HydroPool hot tub.

Recognized for quality worldwide, we are confident that your new hot tub will provide you, your family and friends, with years of enjoyment and fulfill all your hydrotherapy needs.

HydroPool hot tubs are not only healthful and relaxing, they can even add value to your home.

**Please take the time to carefully read and understand all the safety, installation and operating instructions in this manual before electrically connecting your hot tub and adding water.**

The following pages contain valuable information and pointers that will save you both time and money, as well as help you to simplify upkeep and maintenance.

Since we manufactured our first hot tub in 1985, the HydroPool team has been dedicated to producing a quality product catering to maximum hydrotherapy, comfort, energy efficiency and ease of operation.

We are confident that as you become more familiar with the various safety and maintenance features of your new hot tub you will be satisfied that you made the right decision in purchasing a HydroPool hot tub.

Happy hot tubbing...



David Jackson  
President

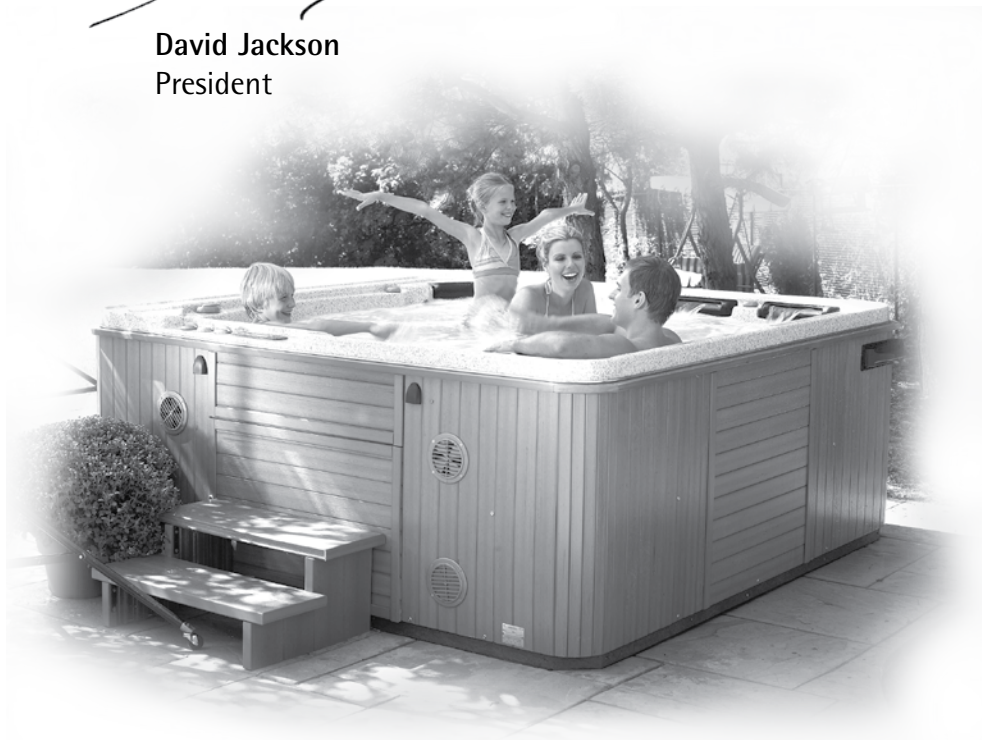

# SAVE THESE INSTRUCTIONS

## IMPORTANT USER SAFETY INSTRUCTIONS

Your physiological response to hot water is subjective and depends on your age, health, and medical history. If you don't know your tolerance to hot water, or if you get a headache, or become dizzy or nauseous when using your hot tub, get out and cool off immediately.

### WARNINGS



- 1** Children should NOT use a hot tub without alert adult supervision.
- 2** Children should not enter a hot tub where water temperature exceeds body temperature (37°C / 98.6°F).
- 3** Prolonged immersion in water temperatures in excess of 38°C (100°F) may be injurious to your health. We recommend establishing lower temperatures and shorter use periods for young children and/or those users potentially affected by hot temperatures. **Always confirm water temperature with an accurate thermometer before entering your hot tub.**
- 4** Do not allow children to submerge their head under water.
- 5** Do not use a hot tub unless all suction guards are installed to prevent body and hair entrapment. Do not sit in front of, or on top of the suction fittings or skimmer, as this will obstruct proper circulation and may result in personal injury.
- 6** Never operate the hot tub pump at high speed without having all suction and return lines open.
- 7** Always keep the hardcover installed and locked when the hot tub is not in use.
- 8** People using medications and/or having any adverse medical history should consult a physician before using a hot tub.
- 9** People with infectious diseases should not use a hot tub.
- 10** Exercise caution when entering or exiting a hot tub. Where practical, install a safety grab bar or handrail. Turn off the jets before entering the hot tub to improve visibility of the steps or flat entry area.
- 11** To avoid unconsciousness and possible drowning, do not use drugs or alcohol before or during the use of a hot tub.
- 12** Pregnant woman should consult a physician before using a hot tub.
- 13** Do not use a hot tub immediately following strenuous exercise.
- 14** Do not permit or use electric appliances (such as a light, telephone, radio or television) within 1.5 m (5 ft) of this hot tub, unless such appliances are rated at 12VDC or less.
- 15** Test the GFCI (Ground Fault Circuit Interrupter) monthly.
- 16** Post emergency phone numbers for Police, Fire Dept., and Ambulance at the nearest phone.
- 17** Maintain water chemistry/balance in accordance with manufacturer's instruction

### HYPERTHERMIA

Since your hot tub can be set to reach temperatures of 40°C (104°F), users should be aware that extended submersion in water that exceeds normal body temperature can lead to hyperthermia.

The causes, symptoms and effects of hyperthermia may be described as follows:

Hyperthermia occurs when the internal temperature of the body reaches several degrees above the normal body temperature of 37°C (98.6°F). The symptoms of hyperthermia include drowsiness, lethargy, and an increase in the internal temperature of the body. The effects of hyperthermia include:

- Unawareness of impending hazard
- Failure to perceive heat
- Failure to recognize the need to exit the hot tub
- Physical inability to exit the hot tub
- Fetal damage in pregnant woman
- Unconsciousness resulting in the danger of drowning

**If you sense any of the symptoms of hyperthermia, safely exit the hot tub immediately.**



### WARNING

THE USE OF ALCOHOL, DRUGS OR MEDICATION CAN SIGNIFICANTLY INCREASE THE RISK OF FATAL HYPERTHERMIA.



## CHOOSING THE RIGHT LOCATION

Your HydroPool hot tub can be installed indoors or out, on the ground, in the ground or half-and-half. The following information will assist you in choosing the right location for your individual needs. When making your decision, always remember that hot tubs can be enjoyed year-round, indoors or out, regardless of the climate. Many HydroPool owners report that their favourite time to use a hot tub is in the cooler fall and winter months, while others praise the enjoyment of using their hot tub in the warmer spring and summer months.

### INDOOR LOCATIONS

If members of your family are not cold weather enthusiasts, or if your backyard or patio area is not suitable for a hot tub installation, then an indoor location for your hot tub may be your best or only choice. You may wish to create an exercise/spa area in your home, or install your hot tub in a glass solarium or four-season room adjoining your home.

Indoor installations not only add a unique look and appeal to your home, they provide the privacy and controlled climate to ensure that use and enjoyment of your hot tub is maximized.

If you are considering an indoor location, HydroPool manufactures certain lower profile models in two pieces (referred to as 'split' models) that can be easily moved into most tight or difficult access locations and then assembled on-site by your authorized HydroPool dealer.

These 'split' and lower profile versions are designed to accommodate narrow doors or shallow stairwells. Since the dimension from the seat to the top of the lip is identical to the "regular profile" units, water submersion, for even the tallest user, is the same.

Your HydroPool dealer can even arrange for your hot tub to be shipped without a cabinet or with the cabinet packaged separately for on-site installation. In many cases the smaller dimensions of a hot tub without a cabinet is all that is needed to ensure the hot tub can be delivered without wall or door alterations.

Where the hot tub is being recessed, or a custom deck or tile is being installed, the cost savings of being able to order a hot tub without a cabinet is another benefit of choosing HydroPool.

If you should choose an indoor location, you will find further information as outlined in the section "SPECIAL CONSIDERATIONS FOR INDOOR INSTALLATIONS"



### OUTDOOR LOCATIONS

For a variety of reasons, outdoor locations are a far more popular choice. Some of the reasons include:

- Limited indoor space
- Delivery complications due to door openings, stairwells, etc.
- Limited budget (indoor installations usually also involve interior home renovations)
- Desire for an outdoor entertainment center
- Hot tub is being installed adjacent to an existing or planned swimming pool
- Concerns over splashing water inside the home

For those who choose an outdoor location, hot tub operating temperatures can be adjusted to match the season. In colder months, many owners will operate their hot tub in the range of 38-40°C (101 -104°F). During warmer months, an operating temperature of 36-37°C (97-99°F) will provide a refreshing retreat.

If you should choose an outdoor location, you will find further information as outlined in the section "SPECIAL CONSIDERATIONS FOR OUTDOOR INSTALLATIONS"



## GENERAL INSTALLATION CONSIDERATIONS

- 1 Your HYDROPOOL Hot Tub is a self-contained pre-plumbed unit, so that no on-site plumbing connections to the residential water supply or drain are required.
- 2 Ensure that your HYDROPOOL Hot Tub is properly supported by either a level concrete pad, or a properly constructed deck capable of supporting 1220 kg/m<sup>2</sup> (250 lbs./ft.<sup>2</sup>). If there is a possibility that the pad could shift by freezing/thawing ground movement (such as in clay regions, and/or areas with high water tables) concrete footings extending below the frost line are recommended.
- 3 Decking should be chosen and constructed in a manner that minimizes the chance of slipping or falling.
- 4 Level your hot tub using wood shims where necessary, ensuring that the tapered end extends at least 61 cm (24 in.) under the unit.
- 5 If you do not have a factory installed foamed cabinet, it is assumed that you are building your own custom cabinet, tiling or decking. Please consider the following:
  - a Your HYDROPOOL Hot Tub is self-supporting on its base. The cabinet should be decorative only, not for support. Never suspend the hot tub from the deck or cabinet.
  - b Where the hot tub is not equipped with a factory installed cabinet, it is the installer's responsibility to ensure all electrical equipment is weather protected.
    - c Always provide adequate access for servicing the support equipment.
    - d Decking should be constructed to allow repair access around the entire hot tub.
    - e In remote equipment or no-cabinet installations, you may add extra insulation, but the equipment area must have adequate cross-flow ventilation.
- 6 Installation of a safety grab rail or reachable support for use when entering or exiting the hot tub is recommended.
- 7 A nearby garden hose connection is recommended for filling and "topping up" the hot tub.



The hot tub equipment and all electrical plugs, outlets and lights within 1.5m (5ft) of the hot tub must be G.F.C.I protected. Consult your electrician or local electrical authority for further details.

Access to the hot tub must always be secured: **Outdoors** - in accordance with local property by-laws and/or via an approved fence with a self-closing gate and a safety hardcover; **Indoors** - by a lockable door and a safety hardcover.

## SPECIAL CONSIDERATIONS

### INDOOR INSTALLATIONS

- When the hot tub is to be installed in a small room (under 150 ft<sup>2</sup>/14 m<sup>2</sup>), we recommend that large units be fully or partially submerged in-floor so that it does not dominate the room. This will also provide greater overhead clearance for entry and exit to and from the hot tub
- It is beneficial to have the hot tub room located near wash room and shower facilities
- The hot tub room should have a floor drain to handle splash water, a window, outside exhaust fan or humidistat controlled exhaust fan for ventilation. Where this is not practical, the use of indoor/outdoor carpeting or a tile floor and the opening of a window while the hot tub cover is removed should be sufficient. You should not have concerns regarding humidity. When the hardcover is installed, no humidity will escape. During use, the small amount of humidity released into the room can be removed with the use of a dehumidifier
- Consider plumbing a water tap and drain location nearby to facilitate draining and top-up
- **Always provide adequate ventilation for the support equipment**
- Consult your local Hydروpool retailer for further information

### OUTDOOR INSTALLATIONS

- Contact your local building code department to determine if a building permit is necessary and for information on applicable bylaws (distance from property lines, buildings, fencing requirements, etc.)
- If you are doing any excavating, contact your local gas, electric, and cable-company to ensure that there are no underground lines
- Locate the hot tub, where practical, within close distance of a door to the house to maximize potential winter use.
- Ensure that all hot tub support equipment is easily accessible and protected from the elements
- If possible, locate the hot tub where you will enjoy some privacy, out of the site of neighbours. If this is not possible, a partial privacy or wind partition, or proper placement of the optional Hydروpool cover lifter should provide adequate privacy
- The hot tub support equipment is designed for indoor (out of the direct elements) use. When your HYDROPOOL hot tub is equipped with a factory-installed cabinet, and installed as per the guidelines of this manual, the equipment will be adequately protected. **If the hot tub is shipped without a cabinet, your custom cabinet or other structure must be designed to supply protection for the hot tub support equipment from rain, snow, splash water, etc., but still designed in a manner to ensure adequate ventilation.**

## SITE PREPARATION

### ABOVE-GROUND INSTALLATIONS

Where the hot tub is a "stand-a-lone" above-ground installation to be installed in regions where freeze/thaw conditions may occur, a level patio stone or pre-formed paver type base may be sufficient if there is no abutting deck(s) that could be damaged during potential seasonal movement of the ground. The potential drawback to this type of base is that splash water could eventually de-stabilize the ground under the base, with the resultant shift of the support base causing damage to the hot tub structure.

For best results, we recommend the installation of a level concrete pad:

- Dig out and level the ground 20-30 cm (8-12 in.) below your desired base level
- Install 10-15 cm (4-6 in.) of crushed stone
- Next, install 10-15 cm (4-6 in.) of poured concrete
- Level the concrete and apply a broom-type finish
- We recommend that the pad be made 15 cm (6 in.) larger than the hot tub on three sides, and 1 m (3 ft.) larger on the side where the access steps and/or planters will be installed

In regions where freeze/thaw occurs, or where there will be custom decking abutting the hot tub we recommend the installation of sono-tubes beneath the pad to prevent shifting.

### IN-GROUND & PARTIAL IN-GROUND INSTALLATIONS

For units being installed fully or partially in the ground, the type of support will again vary based on whether or not the tub is being installed in an area with freeze/thaw conditions. HydroPool does not recommend back-filling full in-ground or partial in-ground installations.

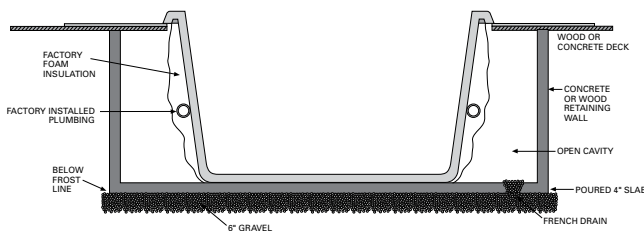

- **Non-freezing climates** – it is sufficient to ensure that the base of the hole or cavity created for the tub has a dry, stable, compacted level base and proper drainage
- **Climates where freeze/thaw occurs** – it is necessary that a poured level concrete base, complete with concrete footings, be installed as outlined in the section ABOVE-GROUND INSTALLATIONS
- **Areas with a high ground water table** – a level concrete base, as well as a concrete or wood retaining wall to hold back the earth, is recommended. This forms a box or 'bunker', in which the hot tub is placed
- **ALWAYS** ensure that there is good drainage, via a properly designed French drain (gravel) system and/or a sump pump, to prevent ground water flooding damage to the support equipment or hot tub structure
- Install protective waterproof conduit to house light, or topside control cables that will be buried
- **Access for future service must be considered at the time of design and installation. Difficult access can result in supplemental service labour charges not covered by the factory warranty. Consider easily removable deck materials.**

### OVERALL SUPPORT

Your HydroPool hot tub is equipped with a factory installed load support substructure, which distributes the weight of the water over the entire foot area of the hot tub. The cabinet, either factory installed or customized on-site, should be decorative only, and not relied on for overall support. **Never suspend a hot tub from a deck or floor by the outer acrylic edge, as this will lead to product damage and/or serious personal injury.**

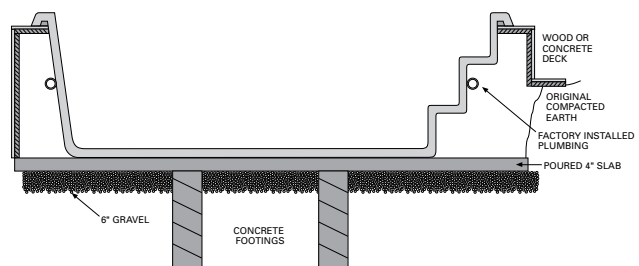

## LEVELING YOUR HYDROPOOL HOT TUB

After the hot tub is properly positioned on the support base, the entire unit should be checked with a level and shimmed as necessary. Should you find that the support base is sloped or otherwise uneven, **level your hot tub using TAPERED wood shims where necessary, ensuring that the tapered end extends at least 61 cm (24 in.) under the unit.** This

will insure contact with the support substructure to appropriately distribute the weight of the unit. Do not just shim under the cabinet base outside edge, as this will cause structural stress on the unit, potentially causing unwarrantable damage to the hot tub structure and /or shell.

## EQUIPMENT ACCESSIBILITY AND PROTECTION

The equipment must be located in an area where it will remain dry and will not be exposed to rain, snow or ground water. The standard HydroPool hot tub has the equipment installed inside the protective cedar cabinet.

- When your hot tub is to be installed above-ground, the cabinet is designed for both protection and accessibility
- When your hot tub is to be installed fully or partially in the ground, if you are relocating the equipment remotely from the hot tub, or if you have ordered a hot tub without a cabinet: it is necessary that the equipment is installed in an area that is dry, protected from the elements, has proper ventilation and is easily accessible for service
- Always ensure that the equipment is mounted on a raised base or platform to prevent potential water damage to the motor, equipment or controls
- Ensure that access to the equipment and the working area around the equipment is large enough to accommodate a service person

## REMOTE EQUIPMENT PLACEMENT

Whenever possible, install the pump(s) and control with heater below water level to ensure easy priming and maximize performance. Where above-grade equipment location is necessary, please ensure that your hot tub is equipped with the Remote Above-Grade Equipment Package.

- The equipment should be located as close to the hot tub as possible to maximize jet performance.
- Where you have ordered your hot tub with optional remote equipment, ensure that the equipment is not located more than 3 m. (10 ft.) from the hot tub.
- Use only 2 in. flex-pipe or larger for the pipe runs from the equipment to the hot tub, with minimal use of elbows or other pipe restrictions.
- Install protective waterproof conduit to house applicable cords or line extensions such as the sensor and top-side control cables, light wires or ozone tubing.
- In climates where freeze / thaw occurs we recommend that remote plumbing lines be buried below the frost line and that pipe insulation is applied over all pipes that run from the hot tub to the remote equipment to help maintain energy efficiency.

## UNLOADING / HANDLING YOUR HOT TUB

All HydroPool hot tubs are shipped with a protective combination layer of foam wrap, cardboard and plastic film. Each hot tub is factory strapped onto a wood skid. If your hot tub is to be delivered by your local dealer, it will generally arrive on a flat bed truck or low profile trailer. Most dealers are equipped with the necessary equipment to maneuver the hot tub from the truck to the dolly or cart that will be used to move your hot tub to the installation location.

Should your hot tub arrive in a common closed box trailer, it may be necessary to arrange with a local towing company for a tilt and load tow truck, with a pulley winch system, to pull the skid from the larger trailer to the lower profile tow truck flat bed. The hot tub can be gently slid off the low profile trailer and positioned on its side on a cart or dolly.

Most HydroPool models require a clearance width of at least 100 cm. (39 in.) to allow movement of the unit on its side through alley-ways, fence openings, etc. Where this is not possible, the use of a crane to lift the hot tub from the truck or trailer over the house to the patio or yard is often a simple and economical option.



- Do not move or place the hot tub on the side where the equipment is located as damage could occur
- Never roll or flip the hot tub end over end as the cabinet could be damaged
- Never lift or handle the hot tub by the plumbing
- Make sure that there is sufficient assistance to gently slide the hot tub off the dolly or cart to the support base without any damage

**Important Note:** Damage caused during transportation or by improper handling is not covered by the factory warranty.

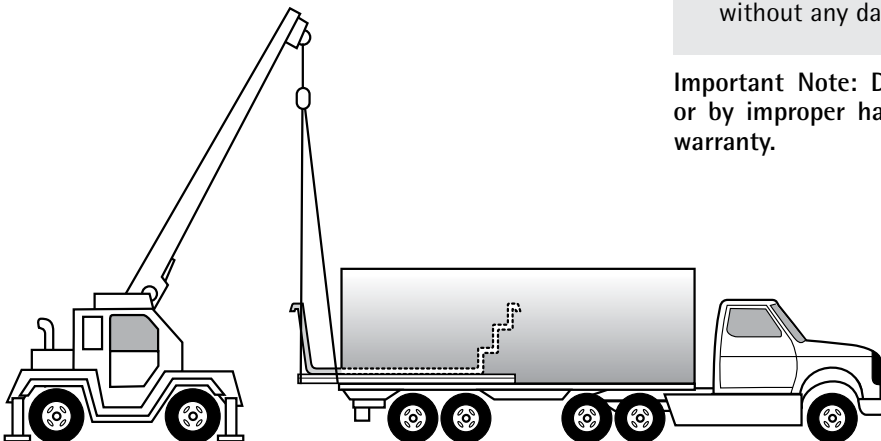



# IMPORTANT ELECTRICAL SAFETY INSTRUCTIONS

SAFETY COMES FIRST. WHEN INSTALLING & USING THIS ELECTRICAL EQUIPMENT, BASIC SAFETY PRECAUTIONS MUST ALWAYS BE FOLLOWED!

- 1 READ AND FOLLOW ALL INSTRUCTIONS
- 2 Electrical installation must be completed by a qualified electrician in accordance with all National, Regional and Local Codes and Regulations in effect at the time of installation.
- 3 Connect only to a dedicated circuit protected by a class 'A' two-pole ground fault circuit interrupter (GFCI)
- 4 Use copper conductors only!
- 5 The hot tub equipment and all electrical plugs, outlets and lights within 1.5m (5ft) of the unit must be G.F.C.I protected. Consult your electrician or local electrical authority for further details.
- 6 A green colored terminal or a terminal marked "G", "GR", "Ground", or "Grounding" is located inside the supply terminal box or compartment. To reduce the risk of electric shock, this terminal must be connected to the grounding means provided in the electric supply service panel with a continuous copper wire equivalent in size to the circuit conductors supplying the equipment.
- 7 At least two lugs marked "BONDING LUGS" are provided on the external surface or on the inside of the supply terminal box or compartment. To reduce the risk of electric shock, connect the local common bonding grid in the area of the hot tub to these terminals with an insulated or bare copper conductor not smaller than No.6 AWG (Canada/Europe) / No.8 AWG (USA).
- 8 All field installed metal components such as rails, ladders, drains or other similar hardware within 3 m (10 ft) of the hot tub shall be bonded to the equipment grounding bus with copper conductors not smaller than No.6 AWG.

<b>G.F.C.I./R.C.D. APPLICATION GUIDE FOR HYDROPOOL SELF CLEAN SERIES</b>	
<b>NORTH AMERICA</b>	
Silver Series/Gold Series	40A
Platinum Series/Luxury Edition	50A
Titanium Series/Titanium Plus Series	60A
<b>EUROPE</b>	
Silver Series/Gold Series/Platinum Series/Luxury Edition	20A
Titanium Series/Titanium Plus Series	40A

## WIRE SIZE

### NORTH AMERICA

- The *minimum* wire size for systems that require a 40A GFCI is #8/3 c/w ground (also referred to as #8 gauge / 4 conductor).
- The *minimum* wire size for systems that require a 50A or 60A GFCI is #6/3 c/w ground (also referred to as #6 gauge / 4 conductor).

### EUROPE

- The *minimum* wire size for European system is 2.5 mm<sup>2</sup> copper wire.

## IMPORTANT NOTE:

- This guide is for standard installations where the wire run is 15 m (50 ft.) or less. For longer wire runs, consult a qualified electrician.

## NORTH AMERICA – GFCI INSTALLATION



**Important Note:** Installation of the GFCI - Circuit Breaker, including ampere sizing and selection of conductor size and type, must be performed by a qualified electrician in accordance with the **National Electrical Code**, or the **Canadian Electrical Code**, and all Federal, State/Provincial and local codes and regulations in effect at the time of installation.

### SIEMENS - TYPICAL

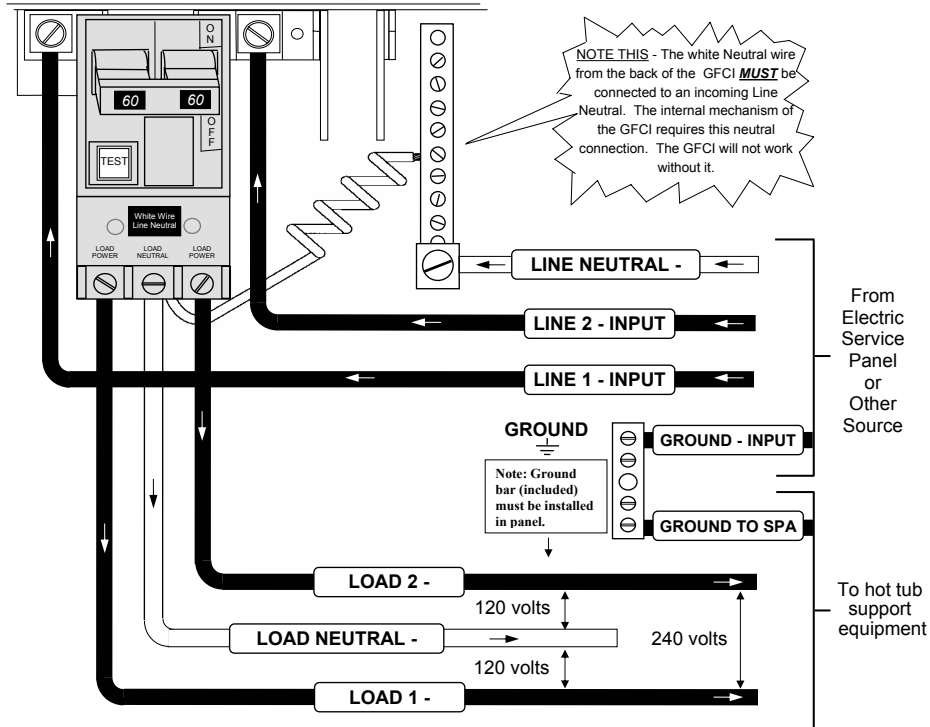

### SQUARE D - TYPICAL

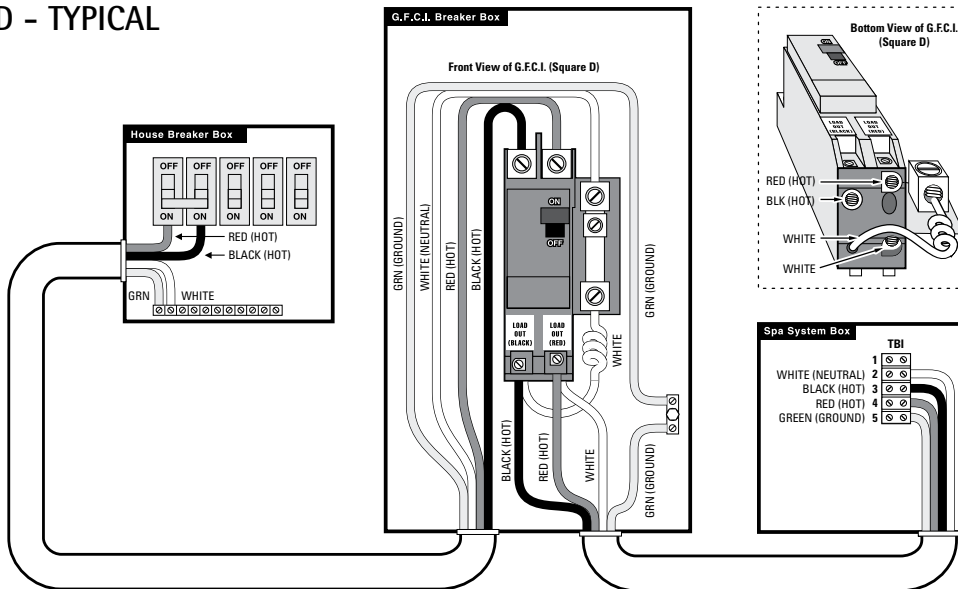

## EUROPE – R.C.D. INSTALLATION - TYPICAL



**Important Note:** Installation of the R.C.D. - Circuit Breaker, including ampere sizing and selection of conductor size and type, must be performed by a qualified electrician in accordance with National, Regional and Local Codes and Regulations in effect at the time of installation.

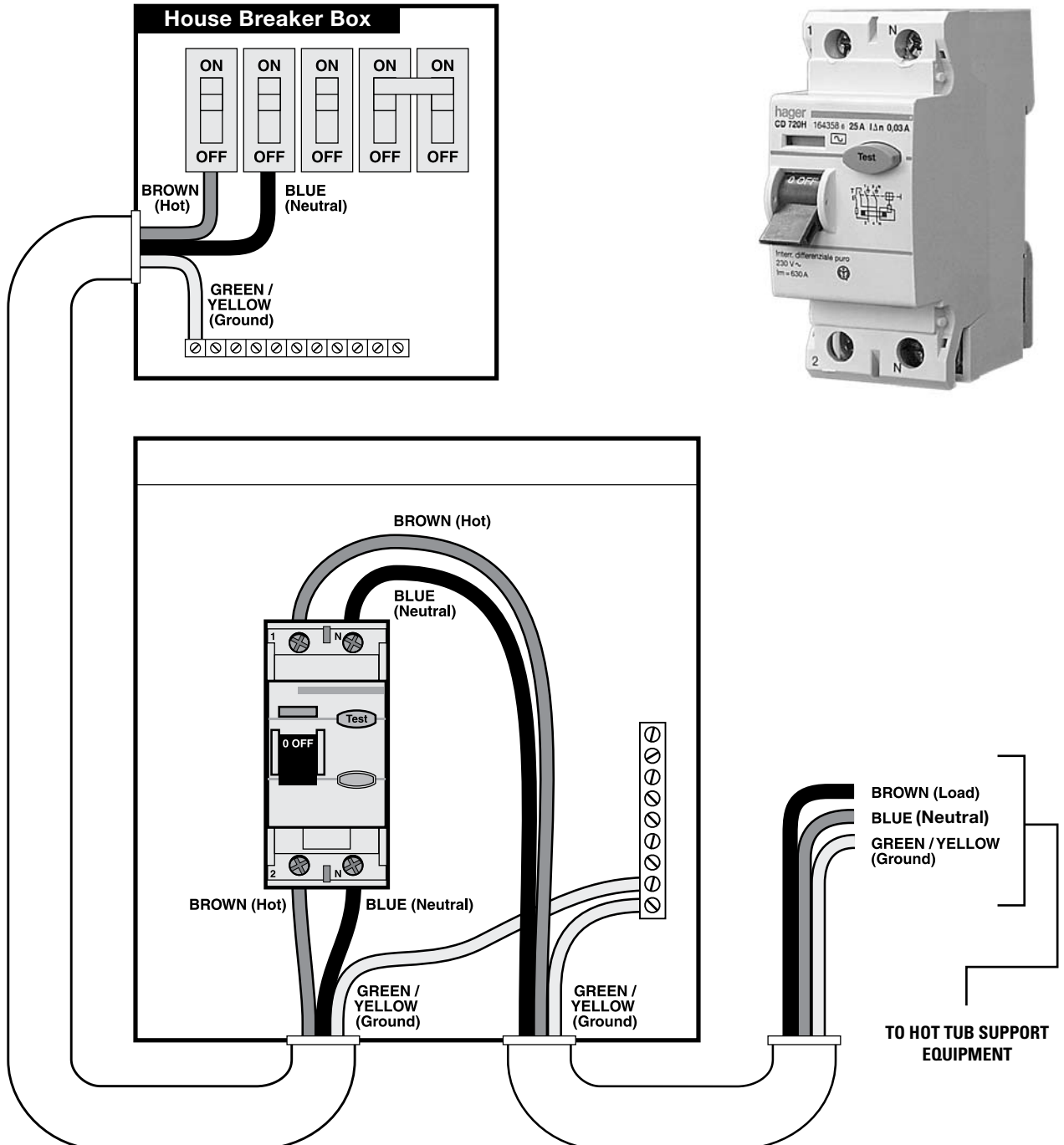

## ACCESSORIES

### PILLOWS

#### TUBULAR PILLOWS

The tubular pillows are a friction fit. Simply compress the ends slightly, and slide into the semi-circular recess above the seat or lounger, with the HydroPool logo facing out.



#### CORNER WRAP PILLOWS

The corner wrap pillows are pre-installed at the factory and are attached via pin and socket. To remove, grasp ends of pillow and pull away from hot tub seat. To re-install, lineup pins on back of pillow to mounting sockets and press firmly.



Although the pillows are designed to remain in-place in the hot tub, to extend the life of the pillows, remove after each use.

#### WATERFALL PILLOWS

If you received the optional waterfall package, remove the blade from the waterfall receiver fitting in the hot tub (already installed at the factory). Insert the waterfall blade through the front of the special waterfall pillow. The front flange of the waterfall blade will be recessed into the front of the pillow. If it is not recessed, the blade needs to be removed and re-inserted through the opposite side of the pillow. Push the pillow into the semi-circular recess, ensuring that the portion of the blade protruding out of the back of the pillow inserts firmly into the waterfall receiver fitting.

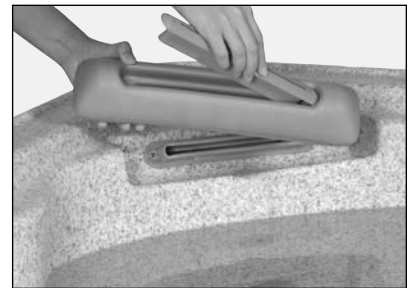
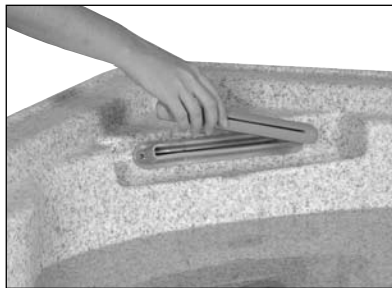
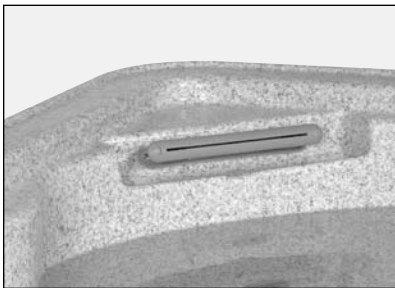



## FILTER/ICE-BUCKET LIDS

The filter and ice-bucket covers provide that finishing touch to your HydroPool hot tub. As the covers are identical to each other, simply place over either opening for a finished appearance.



## LED MOOD LIGHTING

Press the 'light' pad on the topside control to start the following LED lighting modes. Pressing the 'light' pad on/off within 3 seconds cycles through the various 'light shows'. When the LED lighting is turned off for more than 5 seconds, then turned back on, the system will resume the last 'light show'.

Description of Light Shows:

- Mode 1 – Synchronous colour change
- Mode 2 – Freeze mode, freezes on selected colour blend from above mode (gives unlimited colour blend selection)
- Mode 3 – solid colour blue
- Mode 4 – solid colour green
- Mode 5 – solid colour red
- Mode 6 – solid white (simulated)

For systems with optional Galaxy light package:

- Mode 7 – Galaxy lights OFF; interior lights ON
- Mode 8 – Galaxy lights ON; interior lights OFF

## SAFETY HARDCOVER LOCKS

The safety hard cover is designed to open away from the control area, however, if the hot tub is symmetrical in dimension, the cover can be oriented to open in either direction. Simply place the cover on the hot tub, pull the straps down so that they are fully extended, then release slightly so that there is approximately 6 mm (1/4 in.) of slack. Mark the position on the cabinet, and fasten the receiver clip with the screws provided.



### WARNING

Always ensure the safety hard cover is in place and locked whenever the hot tub is not being used.



## OPTIONAL COVER REMOVER

HydroPool offers several different devices to assist in the removal of the safety hard cover. Please refer to the instructions supplied with your particular cover remover for installation. For further information, contact your local HydroPool retailer.



## FILLING, CHECKING AND STARTING YOUR HOT TUB

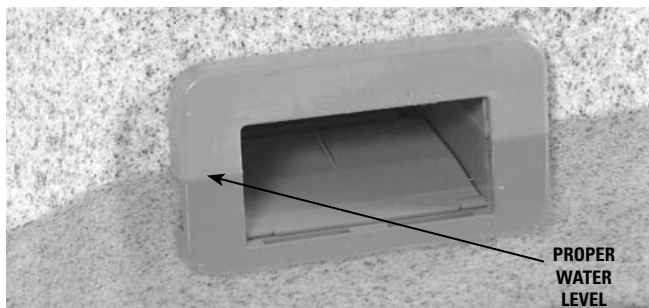
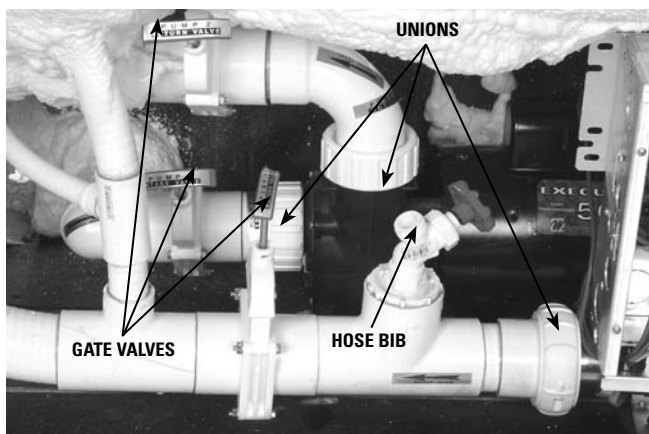

### CHECKING

- Although your hot tub was thoroughly water-tested in the factory, some loosening of fittings can occur during shipping. **Before any decking, tiling or carpeting is completed around the installation, fill and operate your hot tub to test for leaks** (this ensures easy access and inexpensive correction). Check all union connections and plumbing for minor leaks. In the event of a leak, ensure all union connections and pump plugs are tight and all o-rings/gaskets are in place.

### STARTING

- Before applying voltage to power-up your hot tub, it is very important that you understand the sequence of events that occur when the system is activated in order that the pump can be primed efficiently and damage to the system can be avoided.

- Turn the main power "on" at your electrical panel.

- Follow the control instructions for your particular model hot tub to put the pump into low speed. See section HYDROPOOL CONTROL SYSTEMS

### PUMP PRIMING/RELEASING AN AIR LOCK

- On some systems a *PR* message will appear on the display indicating that the system is in PUMP PRIMING MODE. This mode will last for 4 to 5 minutes before automatically entering the normal operation mode. See complete details for your spa in section HYDROPOOL CONTROL SYSTEMS

- When the hot tub pump is located below water level, the water should start circulating immediately. If the motor works but you do not notice water circulation within the first 15 seconds, the pump may require priming due to trapped air (referred to as an 'air lock'). To prime, open the hose-bib to allow trapped air to escape. Close as soon as the water flow from the jets becomes regular. If the pumps have not primed after 2 minutes, and water is not flowing from the jets, **DO NOT allow the pumps to continue to run**. Turn power off at the main house panel (or GFCI) and try releasing the air again by loosening the union on the discharge side of the pump(s) while the motor is not running. Turn the power back on. If the pump(s) does not prime after 15 seconds, sometimes momentarily turning the pump(s) off and on will help the system to prime (note: do not do this more than 5 times).

- **Important: Under NO circumstances should the pump(s) be allowed to operate without priming beyond 5 minutes, as this may not only cause unwarrantable damage to the pump, it may also cause the control system to go into an overheat condition.**

Definition: 'Priming' a pump is a term used to describe the process in which air trapped in the plumbing and pump wet-end (referred to as an 'air lock') is released, allowing the pump to move water efficiently through the plumbing system and to the jets.

### FILLING

- When adding water for the first time, **the hot tub should be filled through the skimmer opening** (helps to prevent air locks) using a standard garden hose, turning the tap on slowly to prevent damage to the surface by a jerking hose connection.
- Pull up the handles on the intake and return gate valves (handles are pulled up when valves are open and pushed down when valves are closed).
- Ensure the drain hose-bib is closed.
- Ensure that all jets are open. See section JET & FEATURE OPERATION
- Fill the hot tub to the recommended level, approximately 19 mm (3/4") from the top of the skimmer opening.

### RELEASING AIR TRAPPED IN FILTER...



**AIR VENT VALVE**

- When the pump starts circulating on low speed, it will be necessary to release trapped air in the filter. Carefully loosen the vent valve counter-clockwise until there is the hissing sound of air escaping. Once there is a steady stream of water, close the vent valve, ensuring that the o-ring does not become pinched.
- Turn the pump onto high speed and re-check for leaks. The control system will automatically return the pump to low speed after 15 minutes.
- Adjust the hot tub heat control at the topside panel to the desired water temperature.
- Adjust water balance (pH, TA, calcium hardness) to recommended levels and add sanitizer. See section HOT TUB WATER MAINTENANCE
- The hot tub will require 8-10 hours to reach the desired temperature.
- Keep insulated safety hard cover on the hot tub, and the air controls closed during the entire heat up process.

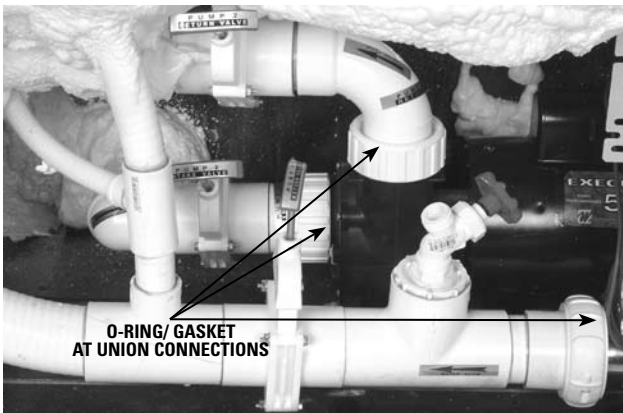

**O-RING/ GASKET AT UNION CONNECTIONS**

### RELEASING AN AIR LOCK...

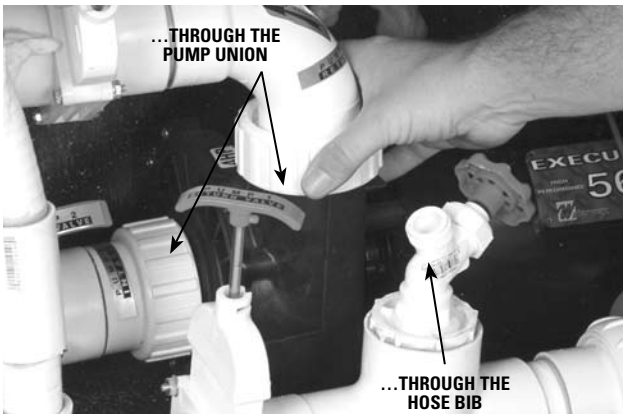

**...THROUGH THE PUMP UNION**

**...THROUGH THE HOSE BIB**

### WINTER DRAIN PLUGS



**WINTER DRAIN PLUGS**

# HYDROPOOL SELF CLEAN SERIES CONTROL SYSTEMS NORTH AMERICA / EUROPE

## HYDROPOOL SELF CLEAN – SILVER & GOLD SERIES

North America



Europe





### TEMPERATURE CONTROL FUNCTIONALITY AND ADJUSTMENT

After you manually exit or the system automatically exits PRIMING MODE, your hot tub will automatically heat to the factory preset default temperature of 38°C (100°F) The topside panel will briefly show the default temperature, and then the display will appear as follows:

### INITIAL START-UP

Before applying voltage to power-up your hot tub, it is very important that you understand the sequence of events that occur when the system is activated in order that the pump can be primed efficiently and damage to the system can be avoided.





 At initial power-up, this display will appear, and the system will show 4 sets of numbers in succession (ie. 49 then 63 then 37 then 24). These numbers represent the current software revision, and the system input voltage.

 After the initial software indicators are shown, this display will appear. This display is indicating that the system is in **PUMP PRIMING MODE**. This mode will last for 4 to 5 minutes before automatically exiting and entering the normal operation mode. You can also manually exit PUMP PRIMING MODE after the pump is primed.

While in this mode, the heater circuit is disabled to allow the priming process to be completed without the possibility of energizing the heater element during low flow or no flow conditions. The system will not automatically activate any of the functions, however, by pushing the  pad on the topside control, the pump can be manually activated to facilitate priming.

**Definition:** 'Priming' a pump is a term used to describe the process in which air trapped in the plumbing and pump wet-end (referred to as an 'air lock') is released, allowing the pump to move water efficiently through the plumbing system and to the jets.

### PUMP PRIMING MODE

 As soon as 'PR' is indicated on the topside panel, push the  pad to start Pump 1 in low speed, then again to switch to high speed to facilitate priming. See FILLING, CHECKING AND STARTING YOUR HOT TUB for complete instructions on pump priming. Once pump priming has been successfully completed, press the  pad to turn off the pump. Next, manually exit PRIMING MODE by pressing the  pad. If you do not manually exit PRIMING MODE, it will automatically terminate after 4 to 5 minutes. Be sure that the pump is primed before exiting this mode.



 Note that the water temperature is not yet displayed, as the system requires approximately 2 minutes of water flow through the heater to determine temperature. This is referred to as 'polling' and is indicated on the display by the -- icon. After 2 minutes the display will show the current measured water temperature



Press the  pad to increase the temperature to the desired setting. The Heat indicator light on the Topside Panel will shimmer for 90 seconds, indicating that the system is not yet heating, then will illuminate solidly to indicate that the heater circuit has been energized and the spa water is being heated.

In Standard Operating Mode, the system automatically activates Pump 1 low speed every 30 minutes for at least 2 minutes. After 2 minutes, the spa water temperature is determined. At this point, if the water temperature is lower than the set temperature, P1 will continue to run and the Heat indicator light on the Topside Panel will illuminate. The heater will operate until the water temperature reaches the set temperature point, after which, both the heater and Pump 1 low will automatically turn off.

### TO CHECK/CHANGE THE SET TEMPERATURE

 The last measured temperature is constantly displayed on the topside panel. When this pad is pressed once any time during normal operation, the display will show the set temperature for 3 seconds. Press this pad a second time to increase or decrease the set temperature. To change the direction of the temperature settings (ie. lower vs. raise the temperature), allow the display to revert back to the current water temperature then press the  pad again.

The temperature can be adjusted from 21°C (70°F) to 40°C (104°F) in 1° increments.

### HEATER FUNCTION

The heater operates with pump low-speed only, and turns off when ever pump high-speed or blower is activated.



## PUMP / JETS FUNCTION

 Press this pad to activate the pump

- 1st press – turns on low speed
- 2nd press – turns on high speed
- 3rd press – turns off pump

When low speed is already operating, the 1st press of the  pad puts the pump directly into high speed.

Low speed starts automatically every 30 minutes to measure water temperature (in STANDARD Mode only – see MODE FUNCTION), when a filter cycle is activated, or when a freeze condition is detected.

When the blower (optional) is manually activated, the pump low speed is automatically activated and operates until the blower times out. If the blower is turned on even briefly, and then turned back off, low speed will operate for a minimum of 2 minutes.

## PUMP AUTOMATIC TIME-OUT



- High speed – 15 minutes
- Low speed – 4 hours

## FILTER CYCLES

The system will automatically activate the pump low speed to filter the water either once or twice each day, and can be programmed by the user. The first filter cycle begins 6 minutes after the spa is initially powered up. The second filter cycle begins 12 hours after the start of the first filter cycle. The filter cycle duration – length of time the pump low runs – is programmable from 1 to 12 hours (F1 to F12). The factory default is 2 hours, twice daily.

## PROGRAMMING FILTER CYCLES

To change the factory default filter cycle settings

Press  then  – the current filter cycle duration will be displayed



Press  again to adjust the filter cycle duration

Press  to exit programming mode and save changes.

## MODE FUNCTION

A combination of keypads is used to change hot tub operation to either 'STANDARD', 'ECONOMY' or 'SLEEP' mode.

## PROGRAMMING MODE FUNCTION

Press  then  – the current mode setting will flash on the display

Press  then  repeatedly to select mode

## STANDARD MODE

The system automatically starts the pump low speed every 30 minutes to measure water temperature, and maintain the set temperature. The display will show *5L* briefly, then the last measured water temperature. The current water temperature is displayed only after the pump has been operating for at least 2 minutes.

## ECONOMY MODE



The system will heat to the set temperature only during the filter cycles. The display will show *E<sub>L</sub>* when the temperature is non-current. When the temperature is current, the display will alternate between *E<sub>L</sub>* and the water temperature.

## SLEEP MODE

The system will heat to within 10°C (20°F) of the set temperature only during filter cycles. The display will show *5L* until the mode is changed.

## STANDBY / DRAIN ASSIST

The standby/drain assist feature stops the system from operating automatically, allowing for convenient filter cartridge removal and for safe draining of the hot tub. The following pads must be pressed within 3 seconds of each other.



Press  then the  pad - the display will flash *SbY*.

If the system is heating when Standby Mode is activated, *SbY* will flash on the display and the pump will continue to operate for 15 seconds to allow the heater to cool off before stopping.

All functions will turn off, but the pump low speed can be activated (by pressing the  pad) to facilitate draining the hot tub - the display will show *DN*.

Press any pad other than the  pad to return the system to normal operation.  
See DRAINING YOUR HOT TUB for detailed instructions.

## LED MOOD LIGHTING

Press the  pad on the topside control to start the selection of LED lighting modes. Pressing the  pad on/off within 3 seconds cycles through the various 'light shows'. When the LED lighting is turned off for more than 5 seconds, then turned back on, the system will resume the last 'light show'.

The system will automatically turn off the mood lighting after 4 hours.

## BLOWER OPTIONAL – FACTORY INSTALLED

 Press this pad to turn the blower on and off.

The system will automatically turn off the blower after 15 minutes.

## PURGE CYCLES BLOWER ONLY

The system automatically activates the blower for 30 seconds at the beginning of each filter cycle to introduce fresh, sanitized water into the blower plumbing circuit.

## OZONATOR OPTIONAL

The ozonator operates during FILTER CYCLES only

## FREEZE PROTECTION

If the temperature sensor detects a drop to 4°C (39°F) within the heater chamber, the system automatically activates the pump to provide freeze protection. The pump will operate until the temperature reaches 5°C (41°F) before returning to normal system mode.

# HYDROPOOL SELF CLEAN SERIES CONTROL SYSTEMS NORTH AMERICA / EUROPE

## HYDROPOOL SELF CLEAN – PLATINUM & TITANIUM SERIES / LIMITED & LUXURY EDITION



Platinum, Luxury Edition



Titanium

### INITIAL START-UP

Before applying voltage to power-up your hot tub, it is very important that you understand the sequence of events that occur when the system is activated in order that the pumps can be primed efficiently and damage to the pumps can be avoided.



At initial power-up, this display will appear, and the system will show 4 sets of numbers in succession (ie. 100 then 114 then 28 then 240). These numbers represent the current software revision, and the system input voltage.

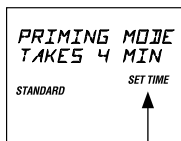

Flashing

After the initial software indicators are shown, this display will appear. This display is indicating that the system is in **PUMP PRIMING MODE**. This mode will last for 4 to 5 minutes before automatically exiting and entering the normal operation mode. You can also manually exit the **PUMP PRIMING MODE** after the pumps are primed.

While in this mode, the heater circuit is disabled to allow the priming process to be completed without the possibility of energizing the heater element during low flow or no flow conditions. The system will not automatically activate any of the functions, however, by pushing the  pads on the topside control, the pumps can be manually activated to facilitate priming.



**Definition:** 'Priming' a pump is a term used to describe the process in which air trapped in the plumbing and pump wet-end (referred to as an 'air lock') is released, allowing the pump to move water efficiently through the plumbing system and to the jets.

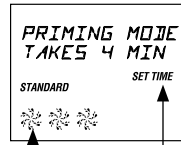

### PUMP PRIMING MODE



Pump Icon(s)

Flashing

As soon as **PRIMING MODE** is indicated on the topside panel, push the left  pad to start Pump 1 in low speed, then again to switch to high speed. Push the center  pad and right  pad to start Pump 2 and \*Pump 3 respectively (\*Titanium Series only). These are both single speed - high only. All of the pumps will now be operating in high speed to facilitate priming. See **FILLING, CHECKING AND STARTING YOUR HOT TUB** for complete instructions on pump priming.

Once pump priming has been successfully completed, press the  pads to turn off the pumps. Next, manually exit **PRIMING MODE** by pressing either the  pad or the  pad. If you do not manually exit Priming Mode, it will automatically terminate after 4 to 5 minutes. Be sure that the pumps have been primed before exiting this mode.

### TEMPERATURE CONTROL FUNCTIONALITY AND ADJUSTMENT

After you manually exit or the system automatically exits **PRIMING MODE**, your hot tub will automatically heat to the factory preset default temperature of 38°C (100°F). The topside panel will briefly show the default temperature, and then the display will appear as follows:

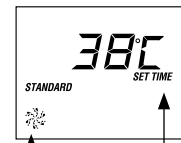

Pump 1 Low speed Icon



Flashing

Note that the water temperature is not yet displayed, as the system requires approximately 2 minutes of water flow through the heater to determine temperature. This is referred to as 'polling' and is indicated on the display by the  icon. After 2 minutes the display will show the current measured water temperature.





Pump 1 Low speed Icon

Flashing

Press the  pad to increase the temperature to the desired setting. The  icon will appear on the display indicating that the heater has been activated.

In Standard Operating Mode, the system automatically activates Pump 1 low speed every 30 minutes for at least 2 minutes. After 2 minutes, the spa water temperature is determined. At this point, if the water temperature is lower than the set temperature, P1 will continue to run and the  icon will appear on the display. The heater will operate until the water temperature reaches the set temperature point, after which, both the heater and Pump 1 low will automatically turn off.

### TO CHECK/CHANGE THE SET TEMPERATURE

  The last measured temperature is constantly displayed on the topside control. When either of these pads is pressed once, the display will show the set temperature. Press either pad a second time to increase or decrease the set temperature. After 3 seconds the display will once again show the last measured temperature.

The temperature can be adjusted from 21°C (70°F) to 40°C (104°F) in 1° increments

### HEATER FUNCTION



Platinum Series, Limited & Luxury Edition: for units connected to a 16A electrical supply service, the heater operates only on pump 1 low speed and turns off when either pump high-speed or blower is activated.

Titanium Series: for units connected to a 32A electrical supply service, the heater operates with any 2 high-speed pumps or 1 high-speed pump and blower.

### PUMPS / JETS FUNCTION

 from left to right on topside control – P1, P2, \*P3 (\*Titanium series only)

#### PUMP 1 (P1)

- 1<sup>st</sup> press – turns on low speed – the P1 icon  spins slowly
- 2<sup>nd</sup> press – turns on high speed – the P1 icon  spins faster
- 3<sup>rd</sup> press – turns off pump – no icon displayed when P1 is off

When P1 low is already operating, the 1<sup>st</sup> press of the P1  pad puts the pump directly into high speed.

Low speed P1 starts automatically every 30 minutes to measure water temperature (in STANDARD Mode only – see MODE FUNCTION), when a filter cycle is activated, or when a freeze condition is detected.

When P2, P3 or the blower is manually activated, P1 low speed is automatically activated and operates until the pump(s) or blower time out. If P2, P3 or the blower is turned on even briefly, and then turned back off, P1 low will operate for a minimum of 2 minutes.

#### PUMP 2 (P2)

- 1<sup>st</sup> press – turns on high speed – the P2 icon  spins fast
- 2<sup>nd</sup> press – turns off pump – no icon displayed when P2 is off.

#### PUMP 3 (P3) – TITANIUM SERIES ONLY

- 1<sup>st</sup> press – turns on high speed – the P3 icon  spins fast
- 2<sup>nd</sup> press – turns off pump – no icon displayed when P3 is off.

### PUMPS AUTOMATIC TIME-OUT

- P1 high speed, P2 & P3 – 15 minutes
- P1 low speed – 4 hours.

### PUMP & BLOWER OPERATING CONDITIONS

Platinum Series, Limited & Luxury Edition

P1 and P2 have priority over the blower. If either pump is on high-speed, the system will not activate the blower until either pump automatically times-out or is manually deactivated by the user. Alternately, if only one of the high-speed pumps is ON and the blower is already ON, when the second high-speed pump is activated, the blower will turn OFF.

Example 1: If P1 and P2 high-speed are activated at the same time, and the blower button is pressed 5 minutes later, the blower will turn ON after a 10 minute delay (balance of the P1 and P2 high-speed time-outs) and operate for 5 minutes (15 minutes minus 10 minutes)



Example 2: If one high-speed pump (either P1 or P2) and blower are activated at the same time, and the second high-speed pump button is pressed 5 minutes later, the blower will automatically turn OFF, but the system will continue the time-out countdown. If 5 minutes later, P1 or P2 is manually turned OFF by the user, the blower will automatically turn ON again and operate for the 5 minutes remaining before the end of the automatic time-out.



### CLEAN-UP CYCLE

The Clean-up Cycle begins 30 minutes after the pump(s) or blower have been turned off or have automatically timed-out. P1 low speed and the ozonator (optional) will operate for one hour.

### SETTING THE SYSTEM CLOCK TIME



The word *TIME* flashes on the topside control display upon initial start-up. This reminder will disappear once the clock time is programmed.

Press  then  to enter programming mode.

To set the hour: Press  or  – each press changes the time by 1 hour.

Press  to enter, and to continue to set minutes.

To set minutes: Press  or  – each press changes the time by 1 minute.

Press the  pad again to continue to the filter cycle programming mode (see below) OR Press the  pad to exit programming mode.

During normal operation, pressing the  pad will display the current time for 3 seconds.



## FILTER CYCLES





Once the system clock time has been programmed, the system will automatically activate P1 low speed to filter the water for 2 hours twice each day. During the filter cycle, the display will show *FILTER1* or *FILTER2*.

### FACTORY PRESET DEFAULT

'**FILTER 1**' the system automatically activates P1 low to operate from 8 AM to 10 AM. The filter 1 (F1) LED indicator on the left side of the topside control panel will light during filter cycle 1 operation.

'**FILTER 2**' the system automatically activates P1 low to operate from 8 PM to 10 PM. The filter 2 (F2) LED indicator on the left side of the topside control panel will light during filter cycle 2 operation.

### PROGRAMMING FILTER CYCLES



To change the factory default filter cycle settings Press  then  then  then  within three seconds.

(You will already have advanced to this point if you pressed  after completing the SETTING THE SYSTEM CLOCK TIME sequence)

At this point *PROGRAM*, *FILTER 1* and *START TIME* will appear on the display



To set the hour: Press  or  - each press changes the time by 1 hour.

Press  to enter, and to continue to set minutes.



To set minutes: Press  or  - each press changes the time by 5 minutes

Press  to enter, and to proceed

At this point *PROGRAM*, *FILTER1* and *END TIME* will appear on the display

To set the hour: Press  or  - each press changes the time by 1 hour.

Press  to enter, and to continue to set minutes

To set minutes: Press  or  - each press changes the time by 5 minutes

Press  to enter, and to proceed

At this point *PROGRAM*, *FILTER 2* and *START TIME* will appear on the display

Adjust time as above Press  to enter, and to proceed

At this point *PROGRAM*, *FILTER 2* and *END TIME* will appear on the display

Adjust time as above

Press the  pad again to enter the filter cycle times into the system and exit programming mode.





The 'F1' light on the left side of the topside control panel will illuminate to indicate that the system is in Filter 1 cycle.

The 'F2' light on the left side of the topside control panel will illuminate to indicate that the system is in Filter 2 cycle.

### PURGE CYCLES

The system automatically activates P2, P3 and the blower for 30 seconds at the beginning of each filter cycle to introduce fresh, sanitized water into these plumbing circuits.

### MODE FUNCTION

 This pad is used to change hot tub operation to either *STANDARD*, *ECONOMY* or *SLEEP* mode. Press  to enter mode programming and press  to select the desired mode. The LCD will flash until  is pressed again to confirm the selection.



### STANDARD MODE

The system automatically starts P1 low speed every 30 minutes to measure water temperature, and maintain the set temperature. The word *STANDARD* will remain on the display along with the last measured temperature. The current water temperature is displayed only after the pump has been operating for at least 2 minutes.

### ECONOMY MODE

The system will heat to the set temperature only during the filter cycles. The display will show the word *ECONOMY*.

### STANDARD-IN-ECONOMY MODE

While the system is in Economy Mode, pressing any  pad or the  pad will cause the system to activate Standard Mode for 1 hour, after which the system will revert back to Economy Mode. Pressing the  pad during this time will put the system back into Economy Mode immediately.

### SLEEP MODE

The system will heat to within 10°C (20°F) below the set temperature only during filter cycles. The display will show the word *SLEEP*.

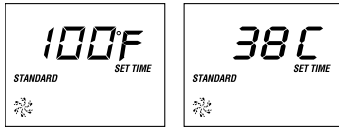

## LIQUID CRYSTAL DISPLAY (LCD)

Continually provides feedback on the operating status of the hot tub. Icons indicate various functions and program information.

### LCD INVERT

This feature inverts the LCD readout for convenient viewing from inside the hot tub. To invert the readout,

Platinum Series: press  or  then   
 Titanium Series: press 





To return the LCD readout to normal viewing (from outside of the hot tub), repeat.

## TOPSIDE PANEL LOCK FEATURES

### TEMPERATURE LOCK



The temperature lock feature prevents unauthorized temperature adjustment of the hot tub water. When the temperature lock is activated, all automatic functions will continue to operate normally.

The following pads must be pressed within 3 seconds of each other to activate the lock:

 then  then P1  then 

### TEMPERATURE UNLOCK

The following pads must be pressed within 3 seconds of each other to deactivate the lock:



 then  then P1  then 

When locked, the TL (Temperature Lock) light on the left side of the topside control panel will illuminate. Only the topside control panel temperature pads will be deactivated.

### TOPSIDE PANEL FULL LOCK



The topside panel lock feature prevents unauthorized use of the hot tub controls. When the topside control panel lock is activated, all automatic functions will continue to operate normally.

The following pads must be pressed within 3 seconds of each other to activate the lock:

 then P1  then 

### TOPSIDE PANEL UNLOCK

The following pads must be pressed within 3 seconds of each other to deactivate the lock:



 then P1  then 

When locked, the PL light (Panel Lock) on the left side of the topside control panel will illuminate. All of the topside control panel pads will be deactivated except for the  pad.

## STANDBY / DRAIN ASSIST

The standby/drain assist feature stops the system from operating automatically, allowing for convenient filter cartridge removal and for safe draining of the hot tub. The following pads must be pressed within 3 seconds of each other.

The system will automatically exit Standby Mode after 1 hour and resume normal operating functions.

Press  then the P2  pad and the display will flash:  
*SBY* (Platinum series)  
*STANDBY* (Titanium series)



If the system is heating when Standby Mode is activated, *SBY* will flash on the display and the pump will continue to operate for 15 seconds to allow the heater to cool off before stopping.

All functions will turn off, but P1 low speed can be activated (by pressing the P1  pad) to facilitate draining the hot tub and the display will show

*DRN* (Platinum series)  
*DRAINING* (Titanium series)

Press any pad other than the P1  pad to return the system to normal operation. See section DRAINING YOUR HOT TUB for detailed instructions.

## LED MOOD LIGHTING

Press the  pad on the topside control to start the selection of LED lighting modes. Pressing the  pad on/off within 3 seconds cycles through the various 'light shows'. When the LED lighting is turned off for more than 5 seconds, then turned back on, the system will resume the last 'light show'. The system will automatically turn off the mood lighting after 4 hours.

## BLOWER OPTIONAL – FACTORY INSTALLED

 Press this pad to turn the blower on and off.

The system will automatically turn off the blower after 15 minutes.

## OZONATOR OPTIONAL

The ozonator operates during FILTER CYCLES and CLEAN UP CYCLES only. The display will show the *O3* icon while the ozonator is operating.

Pressing any pad on the topside control panel will suspend ozonator function for 1 hour.

## FREEZE PROTECTION

If the temperature sensor detects a drop to 4°C (39°F) within the heater chamber, the system automatically activates the pumps to provide freeze protection. The pumps will operate until the temperature reaches 5°C (41°F) before returning to normal system mode.

## TOPSIDE PANEL DISPLAY MESSAGES

**OHH/HTR TEMP LMT/OH/HL** (solid)  
 Overheat – Spa has shut down. One of the sensors has detected 48°C (119°F) at the heater.

**DO NOT ENTER WATER!** Remove cover and allow water to cool. Reset system by pressing any topside control panel pad. If system does not reset, shut off power and call your dealer.

### POSSIBLE CAUSES OF OVERHEATING

- filter cycle too long or overlapping (pump running for extended periods of time)
- isolation/gate valves partially closed
- extremely hot weather/high ambient temperatures
- defective sensor wire

**OHS/SPA TEMP LMT/OH/HL** (flashing)  
 Overheat – Spa has shut down. One of the sensors has detected that the spa water is 44.5°C (112°F).

**DO NOT ENTER WATER!** Remove cover and allow water to cool. At 42°C (107°F) the system should automatically reset. If system does not reset, shut off power and call your dealer.

### POSSIBLE CAUSES OF OVERHEATING

- filter cycle too long or overlapping (pump running for extended periods of time)
- isolation/gate valves partially closed
- extremely hot weather/high ambient temperatures
- defective sensor wire

### **ICE/FREEZE COND**

Potential freeze condition detected. Pumps and blower will automatically activate when temperature drops to 4°C (39°F) regardless of operation mode.

**SnA/SENSOR A SERVICE REQ**  
 Spa has shut down – sensor plugged into Sensor 'A' port not working.

**SnB/SENSOR B SERVICE REQ**  
 Spa has shut down – sensor plugged into Sensor 'B' port not working.

**SnS/SENSOR SYNC**  
 Sensors are out of balance – If topside display alternates between temperature and **SnS**, then occurrence may be temporary and will correct itself. The spa shuts down completely when the **SnS** message is flashing on the display.

**HFL/HTR FLOW LOW**  
 A substantial difference in temperature between the sensors has been detected – this could indicate a flow problem. Check water level in spa and add if necessary. If water level is okay, make sure that pumps are primed and all gate valves are fully opened.

**LF/LOW FLOW**  
 Persistent low flow problem – displays on the fifth occurrence of an **HFL** message within a 24 hour period. Heater circuit is deactivated but other spa functions continue to operate normally. Check water level in spa and add if necessary. If water level is okay, make sure that pumps are primed and all gate valves are fully opened. Press any topside panel pad to reset.

## TOPSIDE PANEL DISPLAY MESSAGES CONTINUED

**DR** / **HEATER MAY BE DRY-WILL RETEST SHORTLY**  
Inadequate water detected in heater chamber - Check water level in spa and add if necessary. If water level is okay, make sure that pumps are primed and all gate valves are fully opened. Press any topside panel pad to reset.

**DRY** / **HEATER DRY SERVICE REQ**  
Inadequate water detected in heater chamber - displays on third occurrence of a **DR** message within a 24 hour period. The spa shuts down completely when the **DRY** message is flashing on the display. Check water level in spa and add if necessary. If water level is okay, make sure that pumps are primed and all gate valves are fully opened. Press any topside panel pad to reset.

**PR** / **PRIMING MODE TAKES 4 MIN**  
Priming mode - occurs when spa is first powered up, or when power has been restored after a power interruption. Allows for safe priming of the pumps. See section HydroPool Self Clean Control Systems for complete details.

**---** / **--F** / **--C**  
Temperature unknown - after the pump has been operating for 2 minutes, the current water temperature will be displayed.

**---** / **----**  
Temperature not current while in Economy or Sleep mode - In either of these modes, the pump may be off for hours in between filter cycles. To view the current spa water temperature, either switch to Standard mode or turn on the pump for at least 2 minutes.

**SBY** / **SEBY** / **STANDBY MODE**  
Stops the control system from operating automatically to allow filter cartridge removal. Press any topside control pad except for P1 to return to normal operation mode.

**DRN** / **DRAINING**  
Allows for convenient draining of the spa using the P1 low speed. Can only be accessed while in Standby mode. Press any topside control pad except for P1 to return to normal operation mode.

**STD** / **STANDARD**  
System is operating in **STANDARD** mode. See section HydroPool Self Clean Control Systems for complete details.

**ECON** / **ECONOMY**  
System is operating in **ECONOMY** mode. See section HydroPool Self Clean Control Systems for complete details.

**SE**  
System is operating in **STANDARD-IN-ECONOMY** mode. See section HydroPool Self Clean Control Systems for complete details.

**SLP** / **SLEEP**  
System is operating in **SLEEP** mode. See section HydroPool Self Clean Control Systems for complete details.

**COOL**  
If spa water temperature is more than 7°C (20°F) cooler than the set temperature, the system will automatically activate the heater to provide freeze protection. This is a normal function; no corrective action is necessary.

## JET AND FEATURE OPERATION

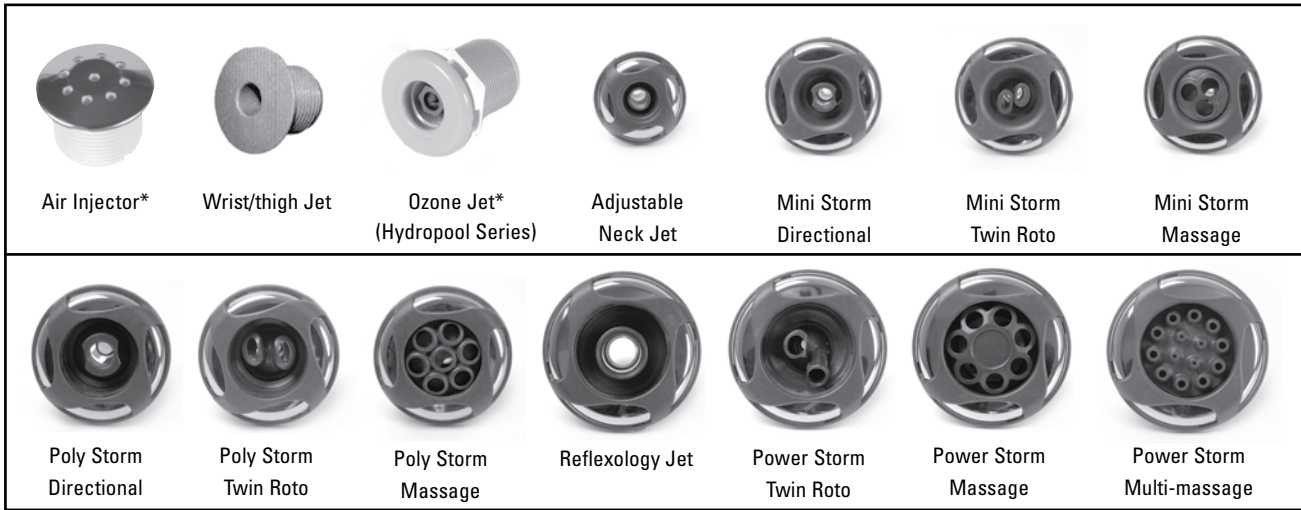

\* indicates a non-adjustable jet

### JET WATER FLOW ADJUSTMENT

Your HydroPool hot tub features adjustable water flow on specific hydrotherapy jets.

To reduce the flow: grasp the outer flange of the jet, and turn clockwise approximately a 1/4 turn. When it hits the stop, the jet is considered closed, and flow will be restricted.

To increase the flow: from the closed position, turn the jet counter-clockwise approximately 1/4 turn. When it hits the stop, the jet is open, and there is maximum jet flow. Do not attempt to turn the jet past the stop, as this will unclip the jet internal from the socket.

### JET AIR FLOW ADJUSTMENT

Your HydroPool hot tub features adjustable air flow on specific hydrotherapy jets.

To reduce the flow: turn the handle on the air control clockwise. When it hits the stop, the air is closed, and air flow will be restricted.

To increase the flow: turn the handle on the air control counter-clockwise. When it hits the stop, the air control is fully opened.

For maximum operating efficiency, the air controls must remain closed when your hot tub is not in use.

All HydroPool hot tubs are shipped from the factory with the jets in the open position.

### INTERCHANGING JET INSERTS

A great feature for custom tailoring the jets in your HydroPool hot tub to suit your personal hydrotherapy needs. Jets of like size and dimension may be interchanged with each other, for example, if you wished to swap a Poly Storm Directional jet for a Poly Storm Twin Roto jet, or a Mini Storm Twin Roto jet for a Mini Storm Directional jet.





## JET INSERT REMOVAL & REPLACEMENT

**POLY/MINI STORM DIRECTIONAL & TWIN ROTO  
POWER STORM MASSAGE & TWIN ROTO**

### TO REMOVE:

- Turn the jet counter-clockwise to unclip & pull out of socket.

### TO RE-INSTALL:

- Push the jet into the socket until it snaps into place, ensuring the square pin on the back of the jet lines-up with the groove in the socket flange.



## DIVERTER VALVE

When your HYDROPOOL hot tub is equipped with a diverter valve, it allows you to direct the flow of the water so that it increases the power of the jets on the CAPTAINS CHAIR or on the LOUNGER, or a combination of the two. Simply turn the valve left or right.

**Always:** return the valve handle to the middle position before exiting the hot tub to ensure that there is air and water flow to the ozone jet and ice-bucket/filter-niche drains for proper performance.

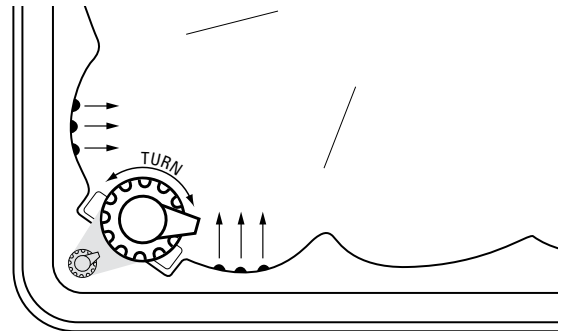

## WATERFALL CONTROL OPTIONAL

If your hot tub was ordered with the optional waterfall feature, then you will have a waterfall flow control valve. The waterfall feature was designed to provide a gentle cascade of water over the neck and shoulder area. Simply turn the top of the control clockwise for less water flow, and counterclockwise for more water flow.

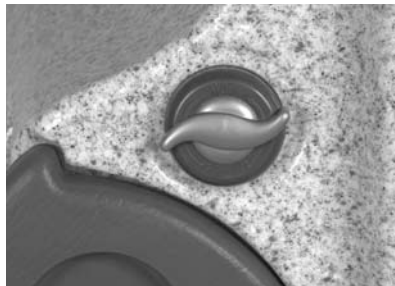

# HYDROPOOL SURROUND SOUND AUDIO & AUDIO/VIDEO SYSTEMS

## Quick-Start Guide

Listening to the Radio .....	28
Playing a CD .....	28
Watching a DVD .....	28

## AM/FM CD Player and MP3 Docking Station

Overview of Controls .....	29
Remote Control Key Map .....	29

### General

Power ON/OFF .....	30
Opening & Closing Front panel .....	30
Input Source Selection .....	30
Clock – Setting & Viewing .....	30

### Audio Control

Adjusting Volume .....	30
Mute .....	30
Bass Level .....	30
Treble Level .....	30
Balance Adjustment .....	30
Fader Adjustment .....	31

### Radio Function

Selecting Band & Storing Presets .....	31
Setting Station Presets Automatically .....	31
Seek & Manual Tune .....	31
Scan .....	31
Preset Station Scan .....	31
Local/Distance Function .....	31

### CD Player Function

Insert, Play & Eject a CD .....	32
Changing CD Tracks & Music Seek .....	32
Intro, Scan, Random & Repeat .....	32

### Audio and MP3 Docking Station

Docking your audio/MP3 .....	32
------------------------------	----

## DVD Player

Overview of Controls .....	33
Remote Control Key Map .....	33
System Setup Menu .....	34

### General

Power ON/OFF .....	35
Screen Saver .....	35
Insert & Eject a DVD .....	35
Input Source Selection .....	35
Mute .....	35
Video Format (PAL/NTSC) .....	35

### DVD Player Function

Play, Pause .....	35
Fast Fwd/Back, Next/Previous .....	35
Display, Title, Subtitle .....	35
Angle, Zoom .....	35
Goto, Clear .....	35
Repeat, A – B .....	35
PBC, Random, Program (VCDs) .....	35

## LCD MONITOR

### Overview of Controls & Remote Control

Key Map .....	36
On Screen Menu Language .....	36
System Setup Menu .....	37

### Monitor Tuner Controls

North American Tuners .....	38
European Tuners .....	38

### Hydopool Optional Waterproof Remote Overview .....

### Hydopool AM/FM CD Player

### Optional Waterproof Remote .....

### Hydopool DVD Player

### Optional Waterproof Remote .....

### Hydopool LCD Monitor

### Optional Waterproof Remote .....

### Hydopool Monitor Tuner

### Optional Waterproof Remote .....

# HYDROPOOL SURROUND SOUND™ AUDIO/VIDEO SYSTEM

## QUICK-START GUIDE

FOR ALL HYDROPOOL HOT TUBS WITH OPTIONAL HYDROPOOL SURROUND SOUND™ SYSTEMS

The following info is a guide to the basic system functions of the HYDROPOOL SURROUND SOUND™ audio/video system package.

### TURNING AM/FM CD PLAYER ON/OFF

- Press the **POWER** button [3] to turn on and off power to the AM/FM CD player

### LISTENING TO THE RADIO

- Press the **SOURCE** button [4] to cycle through available program sources: TUNER -> CD -> AU-1. If there is no CD inserted, then the CD source will not appear.
- When TUNER is selected, station frequency will be indicated on the display.
- Use the **TUNE/SEEK-UP** button [13] and the **TUNE/SEEK-DOWN** button [14] to select station.

### LISTENING TO A CD

- Open the front panel by pressing down the **FRONT PANEL RELEASE** button [7].
- Insert a CD into the disc slot with the label facing up and close the front panel.
- The CD plays automatically after loading.

### WATCHING A DVD

On the LCD Monitor\*:

- Press the **POWER** button on the TV remote.
- Press the **TV/Video** button on the TV remote until 'S-VIDEO' appears on the screen.

On the DVD player:

- Press the **POWER** button [1] on the front of the DVD player or on the DVD remote.
- Insert a DVD into the disc slot with the label facing up.
- DVD playback will begin automatically after the disc is inserted. With some DVD discs, you will need to press the **PLAY** button [10] on the DVD player or the remote to begin playback.

On the AM/FM CD Player:

- Press the **SOURCE** button [4] to cycle through available program sources. Select **AU-1**.

\* Note: the Monitor can only be operated using the factory IR remote or the HydroPool Universal IR Remote.

## AM/FM CD PLAYER

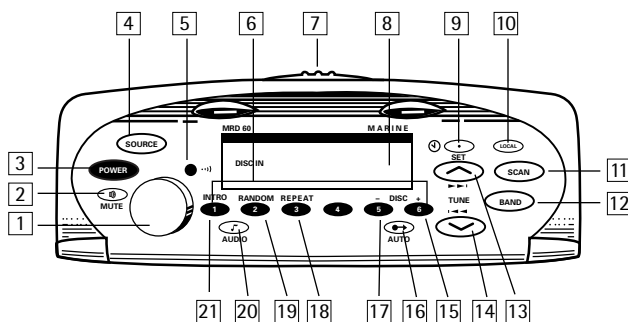

## CD PLAYER

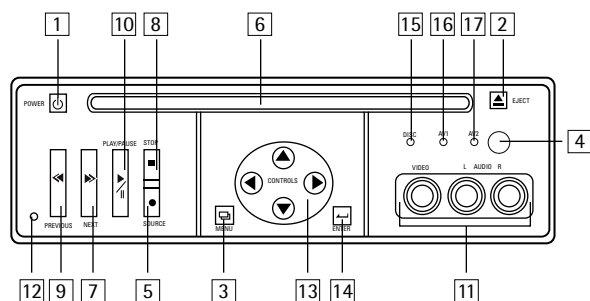

## LCD MONITOR

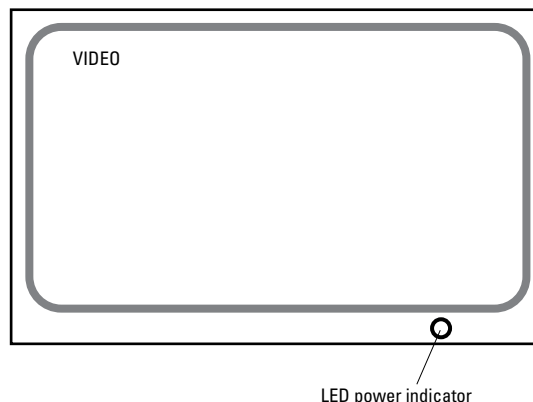

## HYDROPOOL SURROUND SOUND AM/FM CD PLAYER

### OVERVIEW OF CONTROLS

1. Volume control
2. Mute
3. Power ON/OFF
4. Source
5. IR receiver
6. Preset buttons 1 – 6
7. Front panel release
8. Display
9. Clock set
10. Local
11. Scan
12. Band
13. Tune/seek up
14. Tune/seek down
15. Disc +
16. Auto
17. Disc -
18. CD repeat
19. CD random
20. Audio
21. CD intro

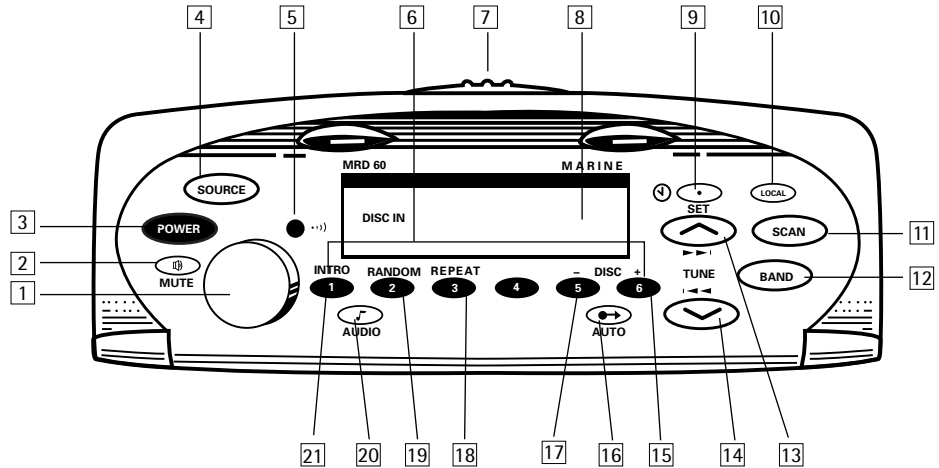

### IR REMOTE CONTROL KEY MAP

Basic functions can be controlled via the AM/FM CD player or the IR remote control

1. Power ON/OFF
2. Volume Zone 1
3. Mute
4. Source
5. Band
6. Tune/seek up
7. Tune/seek down
8. Auto
9. CD repeat
10. Audio
11. Intro
12. Random
13. Disc - (not applicable)
14. Disc + (not applicable)
15. Amp Source (not applicable)
16. Pause
17. SNC (not applicable)

### HOT TUB CONTROL FUNCTIONS

18. Pump 1 (P1)
19. Pump 2 (P2)
20. Pump 3 (P3)
21. Light
22. Blower

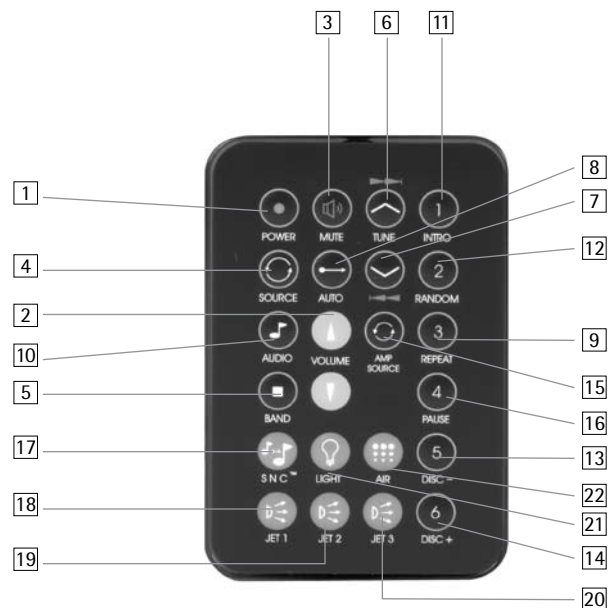

## AM/FM CD PLAYER CONTROLS



### IMPORTANT USER SAFETY INSTRUCTIONS

#### CAUTION – RISK OF ELECTRIC SHOCK

- Do not leave compartment door open
- Replace components only with identical components
- Do not operate the audio/video equipment controls while inside the spa. Use the IR remote control(s) provided

#### WARNING – PREVENT ELECTROCUTION

- Do not connect auxiliary components to the system
- Do not service this product yourself as opening or removing covers may expose you to dangerous voltage or other risk of injury. Refer all servicing to qualified service personnel
- If water enters any electrical equipment compartment area, or if there are other indications of potential damage to the unit, turn off the unit and refer servicing to qualified service personnel
- This unit should be subjected to periodic routine maintenance to ensure that it is operating properly

### GENERAL

#### POWER ON/OFF

- 1 Press the **POWER** button on system or IR remote once to turn system ON, and once to turn system OFF.
- 2 **NOTE: The radio power must be turned on in order to turn on power to the DVD player and the LCD TV.**

#### OPENING AND CLOSING THE FRONT PANEL

- 1 **OPEN:** Place thumb on the front panel release button, and forefinger below the front panel overhang. Firmly depress the release button while gently pulling the front panel
- 2 **CLOSE:** flip up front panel and press firmly until you hear an audible click
- 3 Except when changing the CD, keep the front panel closed at all times to prevent water intrusion that could cause damage to the system

#### INPUT SOURCE SELECTION

- 1 Press the **SOURCE** button to cycle through available input sources. Sequence is TUNER -> CD -> AU-1
- 2 If a CD is not inserted into the CD player, that input source will not appear on the display. Sequence is TUNER -> AU-1

### CLOCK

#### VIEWING THE CLOCK

- 1 Press the **SET** button to toggle the display between clock and radio mode. Unit will automatically display clock time whenever radio controls are not being used

#### SETTING THE CLOCK

- 1 Press and hold the **SET** button for 2 seconds, until the first digit of the time starts flashing
- 2 Use the **TUNE/SEEK-UP** or **TUNE/SEEK-DOWN** buttons to adjust the hour. Note the AM/PM indicator at the left when setting the hour
- 3 Press **SET** again to select the minutes. Adjust as above
- 4 Press the **SET** button one final time to save the input and complete setting time
- 5 The system will automatically return to clock mode, and the time will appear after 3 seconds

### AUDIO CONTROL

#### ADJUSTING THE VOLUME

- 1 Controls volume for the AM/FM radio/CD player, and also for the TV and DVD player
- 2 Rotate **VOLUME** knob to increase or decrease volume (0-31)
- 3 Current volume setting is momentarily indicated on the display
- 4 **When watching TV or viewing a DVD: set the volume level to '15' and use the TV volume to control sound levels**

#### MUTE

- 1 Press the **MUTE** button once to mute the sound. 'MUTE' will flash on the display
- 2 Press the **MUTE** button again or rotate the volume knob to resume audio

#### BASS LEVEL

- 1 Press the **AUDIO** button until 'BAS' appears on the display
- 2 Rotate the **VOLUME** knob to adjust setting. 'C-0' indicates neutral bass setting (factory default); -2 to -12 indicates reduced bass; +2 to +12 indicates increased bass
- 3 Unit will automatically return to volume mode if an input is not detected for 3 seconds

#### TREBLE LEVEL

- 1 Press the **AUDIO** button until 'TRE' appears on the display
- 2 Rotate the **VOLUME** knob to adjust setting. 'C-0' indicates neutral treble setting (factory default); -2 to -12 indicates reduced treble; +2 to +12 indicates increased treble
- 3 Unit will automatically return to volume mode if an input is not detected for 3 seconds

#### BALANCE ADJUSTMENT

- 1 Press the **AUDIO** button until 'BAL' appears on the display
- 2 Rotate the **VOLUME** knob to adjust setting. 'C-0' indicates center (factory default); R1 to R15 indicates right balance; L1 to L15 indicates left balance
- 3 Unit will automatically return to volume mode if an input is not detected for 3 seconds



## AM/FM CD PLAYER CONTROLS

### FADER ADJUSTMENT

- 1 Press the **AUDIO** button until 'FADE' appears on the display
- 2 Rotate the **VOLUME** knob to adjust setting. 'C-0' indicates center (factory default); R1 to R15 indicates rear fade; F1 to F15 indicates left balance
- 3 Unit will automatically return to volume mode if an input is not detected for 3 seconds

### RADIO FUNCTION

Press the **SOURCE** button to select Radio mode. Station frequency will be displayed

### SELECTING BAND AND STORING STATION PRESETS

- 1 Press the **BAND** button to cycle through the 5 sets of radio bands. Sequence is FM1 -> FM2 -> FM3 -> AM1 -> AM2. Each band stores up to 6 independent presets, for a total of 18 FM and 12 AM presets
- 2 To program a preset: tune into the desired station, press and hold for 2 seconds the numeric button that will be used to store this preset. 'PX', where X represents the preset number, will be displayed on the bottom right of the display (i.e. P6)
- 3 If power to the hot tub is interrupted, or the reset switch is pressed, the station presets will need to be reprogrammed

### SETTING STATION PRESETS AUTOMATICALLY

- 1 To automatically program the station presets: press a preset button (1-6) - the system will start the programming sequence at this preset button first
- 2 Hold the **AUTO** button for 2 seconds, or until the programming sequence begins
- 3 The current preset and additional presets up to P6 will be programmed with the next available station signal
- 4 When the auto preset cycle is complete, the unit will remain in preset scan mode (see PRESET SCAN FUNCTION), and will continue scanning the programmed presets until the **AUTO** button is pressed
- 5 To select only the strongest station signals, press the **LOCAL** button
- 6 All 18 FM and 12 AM presets can be stored sequentially by pressing the **BAND** button to enter the next band set (i.e. If you started with FM1 preset buttons, pressing the **BAND** button will step to FM2) and continuing auto programming

### SEEK AND MANUAL TUNE

- 1 Press the **TUNE/SEEK-UP** or **TUNE/SEEK-DOWN** button once to automatically tune to the next strongest higher or lower station signal (auto seek)
- 2 To manually tune to a station signal, press and hold either **TUNE/SEEK** button for 2 seconds. Holding the button down will either increase or decrease through the station frequencies manually
- 3 When the desired frequency is reached, release the **TUNE/SEEK** button. The system remains in manual tune for 3 seconds after the last button is released, so that you can still fine tune with additional button presses
- 4 After 3 seconds the system will return to auto seek mode

### SCAN FUNCTION

- 1 Select any FM or AM band set and press **SCAN** to listen to a few seconds of each radio station. The display will flash, and the system will automatically advance to the next available station signal, play that radio station for a few seconds, then advance to the next available station, etc, etc. To stop scanning and continue listening to the current station, press the **SCAN** button again
- 2 The radio remains in scan mode until the **SCAN** button is pressed a second time or one of the **TUNE/SEEK** buttons is pressed

### PRESET SCAN FUNCTION

- 1 Select any FM or AM band set and press **AUTO** to listen to a few seconds of each radio station preset. The display will flash the preset station number (i.e. P4), and the system will automatically advance to the next preset station signal, play that radio station for a few seconds, then advance to the next preset station signal, etc, etc. To stop scanning and continue listening to the current station, press the **AUTO** button again
- 2 The radio remains in preset scan mode until the **AUTO** button is pressed a second time or one of the preset buttons is pressed

### LOCAL/DISTANCE FUNCTION

- 1 Press the **LOCAL** button to select between local station mode and any station (default) mode. When 'LOCAL' is displayed, only the strongest station signals will be selected during SEEK or SCAN mode.
- 2 In the default mode ('LOCAL' not shown on display), all usable stations with sufficient signal strength will be selected during SEEK or SCAN mode

## AM/FM CD PLAYER CONTROLS AND MP3 DOCKING STATION

### CD PLAYER FUNCTION

#### INSERT, PLAY AND EJECT A CD

- 1 To insert a CD: open the front panel and insert a CD into the slot with the CD label facing up. The CD will be drawn inside the unit. Close the front panel. The system will automatically switch to the CD source mode, and the 'DISC IN' symbol on the display indicates that a CD is in the drive.
- 2 Play: CD playback will begin automatically. The display will show the current track number and the play time of that track. An animated 3-D rotating disc will also show on the display to indicate that a disc is playing
- 3 To remove a CD: open the front panel and press the CD ▲ (eject) button on the inside left of the front panel. Remove CD from the drive, and close the panel.

**CAUTION:** listen for an audible click to indicate that the front panel has been securely closed to prevent water intrusion that could cause damage to the system

### CHANGING CD TRACKS AND MUSIC SEEK

- 1 To advance to the next track: press the **TUNE/SEEK-UP** button once, and the track counter will advance one track. When the final track on the CD is reached, the next press of the button will return to the first track
- 2 To fast forward or rewind through tracks: press and hold the **TUNE/SEEK-UP** or **TUNE/SEEK-DOWN** button. Releasing the button will stop the process and playback will start from that point in the track
- 3 To return to the beginning of the current track: press the **TUNE/SEEK-DOWN** button once at any time during track playback. Pressing the **TUNE/SEEK-DOWN** button a second time within 1 second will skip back to the previous track

### INTRO SCAN, RANDOM AND REPEAT

- 1 Intro Scan: press the **INTRO** button to select Intro Scan Mode, and 'SCN' will appear to the left on the display. The first 10 seconds of each track on the CD will play. To exit Intro Scan Mode, press the **INTRO** button a second time, or the **TUNE/SEEK-UP** or **TUNE/SEEK-DOWN** button
- 2 Random: press the **RANDOM** button to play the CD tracks in a random order, and 'RDM' will appear to the left on the display. To exit Random Mode, press the **RANDOM** button a second time
- 3 Repeat: press the **REPEAT** button to repeat playback of the current track, and 'RPT' will appear to the left on the display. To exit Repeat Mode, press the **REPEAT** button a second time

### AUDIO AND MP3 DOCKING STATION

#### DOCKING YOUR AUDIO/MP3

The Docking Station is compatible with all alternate audio sources such as MP3 players.

To install any audio source:

- 1 Locate and open the Docking Station door by gently pulling upward on the handle.
- 2 Remove the connector cover prior to plugging in your audio source. Always keep the cover on when the docking station is not in use.
- 3 Center the device over the Docking Station Adaptor and connect.
- 4 For stand alone unit that do not have a stereo head unit, make sure to turn on the switch located inside to power the amplifier before you begin.
- 5 Close the Docking Station door once you have begun using your device.



## HYDROPOOL SURROUND SOUND DVD PLAYER

### OVERVIEW OF CONTROLS

1. Power
2. Eject
3. Menu
4. IR receiver
5. Source
6. Disc Slot
7. Next
8. Stop
9. Previous
10. Play / Pause
11. Video / Audio input
12. Reset
13. Cursor buttons
14. Enter
15. Indicator light for DISC
16. Indicator light for AV1
17. Indicator light for AV2

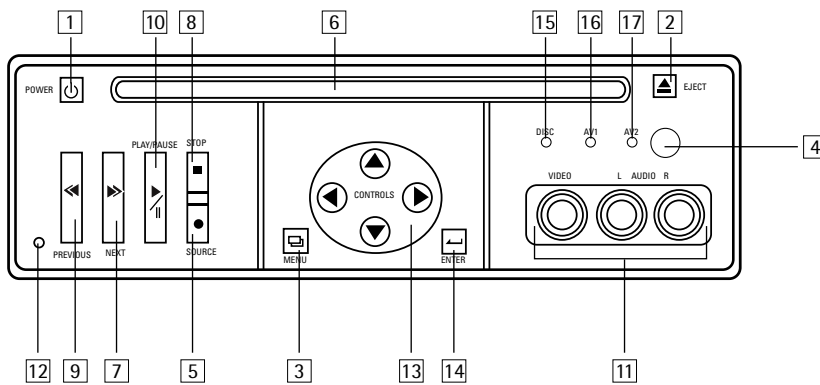

### IR REMOTE CONTROL KEY MAP

Basic functions can be controlled via the DVD player or IR remote control  
 All advanced functions can only be accessed via the IR remote control

1. Power
2. Eject
3. Mute
4. Subtitle
5. Angle
6. Display
7. Source
8. Setup
9. PAL/NTSC
10. GOTO
11. Title
12. Menu
13. Cursor buttons
14. Enter
15. Slow Fwd / Back
16. Play
17. Fast Fwd / Back
18. Next
19. Stop
20. Pause
21. 0 - 9
22. Clear
23. Zoom
24. PBC
25. Random
26. Program
27. Repeat
28. A - B

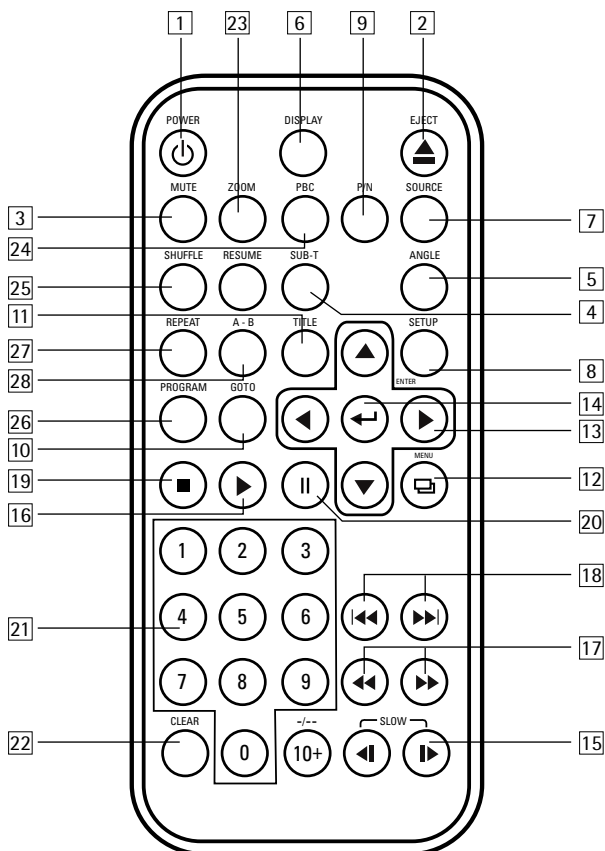

## DVD PLAYER CONTROLS

### SYSTEM SETUP MENU: ON SCREEN MENUS AND DISPLAYS – OVERVIEW

Press the...

1. ...STOP button before proceeding (only if a DVD is playing)
2. ...SETUP button to display the main system setup menu
3. ...CURSOR buttons to navigate the sub-menus
4. ...ENTER button to make selection

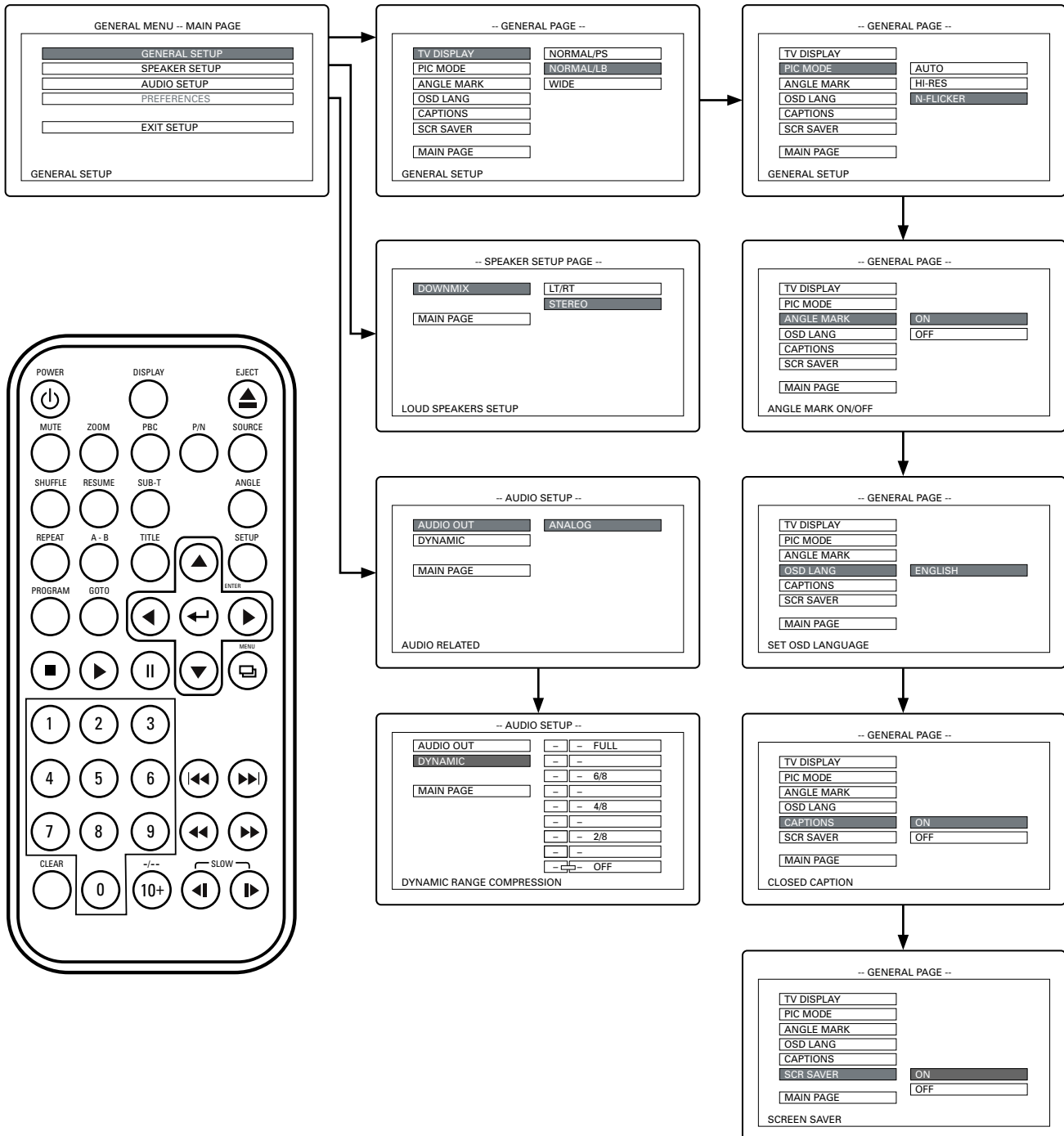

## DVD PLAYER CONTROLS

### GENERAL

#### POWER ON/OFF

- 1 Press the **POWER** button on system or IR remote once to turn system ON, and once to turn system OFF. If there is already a disc in the drive, playback will start automatically.
- 2 **NOTE: Power to the AM/FM CD player must be ON in order to turn ON the DVD player**

#### SCREEN SAVER

- 1 If there is no button input detected for 5 minutes, the screen saver begins automatically
- 2 The screen saver can be turned ON/OFF in the SETUP menu under 'Screen Saver'

#### INSERT AND EJECT A DVD

- 1 To insert a DVD: insert a DVD into the slot with the label facing up. The DVD will be drawn inside the unit. 'DISC LOADING' will show on the TV display indicating that a DVD is in the drive. Note: DVD playback will begin automatically
- 2 To remove a DVD: press the **EJECT** button on the front panel. Remove DVD from the drive

**CAUTION: always ensure the component panel door has been securely closed to prevent water intrusion that could cause damage to the system**

#### INPUT SOURCE SELECTION

- 1 Press the **SOURCE** button to cycle through available input sources. Sequence is DISC -> AV1 -> AV2

#### MUTE

- 1 Press the **MUTE** button on the DVD player IR remote, and the word 'MUTE' will appear momentarily on the TV screen to indicate that the DVD audio is in mute mode. Press the **MUTE** button again to exit DVD audio mute mode, and the words 'MUTE OFF' will appear momentarily on the TV screen

**Note: Use of the DVD mute function is generally not required, as the sound volume is muted through either the LCD TV function or the Radio function**

#### PAL/NTSC

- 1 Press the **P/N** button on the IR remote to select the DVD video playback format:  
NTSC – North American video format  
PAL – European video format

### DVD PLAYER FUNCTION

#### PLAY, PAUSE, FAST FWD/BACK, NEXT/PREVIOUS

- 1 Play: playback begins automatically after disc is inserted. In most cases it will go to the DVD root menu, and it will be necessary to press the **PLAY** or **ENTER** button
- 2 Pause: press the **II** button during playback to freeze the picture (still mode). Press the button again to resume playback

- 3 Fast Fwd / Back: press the **▶▶** or **◀◀** button during playback. Each time the button is pressed, the fast forward/back speed changes as follows:  
DVD – normal -> 2x -> 4x -> 6x -> 8x -> 20x  
VCD – normal -> 2x -> 4x -> 6x -> 8x
- 4 Next / Previous: press the **▶▶I** button to jump to the next chapter (DVD) or the next track (VCD/CD), and press the **I◀◀** button to jump to the previous chapter or track

#### DISPLAY, TITLE, SUBTITLE

- 1 Display: press the **DISPLAY** button on the IR remote to show statistical disc information during playback (chapter, time remaining, counter etc.)
- 2 Title: press the **TITLE** button on the IR remote to display the DVD disc title (not available on all DVD discs)
- 3 Subtitle: press the **SUBTITLE** button on the IR remote to turn on/off subtitle, and/or to select subtitle language on DVD discs with multilingual subtitle options

#### ANGLE, ZOOM

- 1 Press the **ANGLE** button on the IR remote to change the view angle (only available on DVDs that have the multi-angle feature)
- 2 Press the **ZOOM** button on the IR remote to increase the size of the picture. Note that in 'ZOOM' mode, only the enlarged part of the picture will be viewable; the entire picture will not be visible

#### GOTO, CLEAR

- 1 Press the **GOTO** button to select DVD playback chapter using the 0-9 number buttons
- 2 Press the **CLEAR** button to clear a number that was entered in error

#### REPEAT, A – B

- 1 Press the **REPEAT** button on the IR remote to select either repeat chapter in current view, or repeat title. On-screen sequence is CHAPTER REPEAT ON -> TITLE REPEAT ON -> REPEAT OFF
- 2 Press the **A – B** button on the IR remote to select and repeat a particular scene or passage. On-screen sequence is A TO B SET A -> A TO B SET B -> A TO B CANCELLED

#### PBC, RANDOM, PROGRAM (VIDEO CD only)

- 1 Video CDs with PBC (playback control) can be played with or without a menu. On the IR remote, press the **PBC** button to select
- 2 Press the **RANDOM** button on the IR remote to play tracks in random order
- 3 Press the **PROGRAM** button to select and program the order in which to play tracks



## HYDROPOOL SURROUND SOUND LCD MONITOR

### OVERVIEW OF CONTROLS AND IR REMOTE KEY MAP

All functions are accessed with the IR remote control

- 1 **TV/VIDEO** Press repeatedly to cycle source selection between VIDEO, S-VIDEO, YCbCr (Component Video) & PC
- 2 **VOLUME** These two buttons are primarily used in conjunction with the MENU & PICTURE buttons.
- 3 **TV MENU** Press to show the on-screen menu. Press repeatedly to cycle through the available menu items & to clear the menu from the screen.
- 4 **ENTER** Used in conjunction with disc and setup menus.
- 5 **LEFT ◀ ▶ RIGHT** Used in conjunction with disc and setup menus.
- 6 **PICTURE** Press to call up the on screen Picture Menu. Press the **CH ▲/▼** button to cycle through Contrast, Brightness, Sharpness, Color, Tint. The selected item will be displayed in BLUE. Adjust the desired item with the VOLUME buttons.
- 7 **STATUS** Press repeatedly to cycle between a user-adjustable picture and three different preset picture balance settings.
- 8 **MUTE** Press to reduce sound to minimum level. Press again to restore.
- 9 **POWER** Press to turn the LCD monitor on/off.
- 10 **DISPLAY** Press to display information about the current Program source & SLEEP TIMER setting.
- 11 **CHANNEL UP ▲/▼ DOWN** Press to select menu items with some on-screen menus
- 12 **CCD** Press repeatedly to cycle between Closed Captions 1, Closed Captions 2, Text 1, Text 2 and OFF.
- 13 **SLEEP** Sets the sleep timer to automatically power off the monitor.

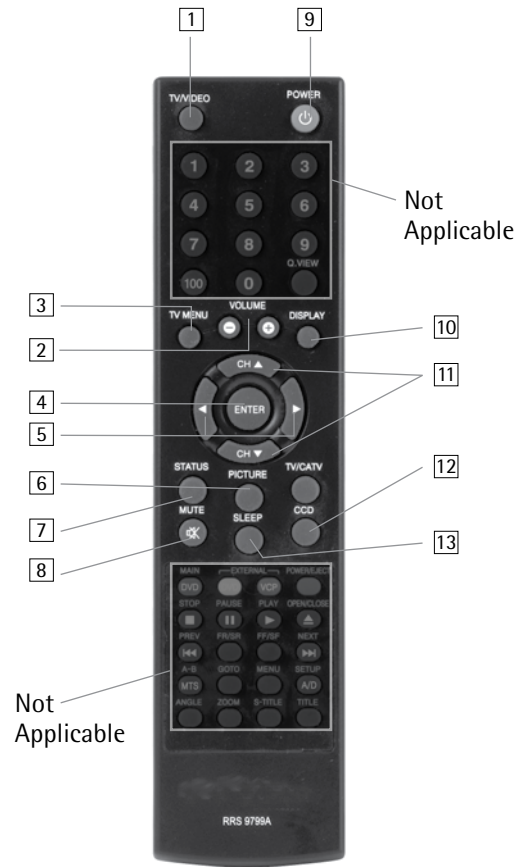

### ON SCREEN MENU LANGUAGE SELECTION

The onscreen display language is selected as follows:

1. Press the **TV/MENU** button
2. **CH ▲/▼** button to reach LANGUAGE mode in FUNCTION.
3. Press the **VOLUME +** button to select desired language
4. Press the **TV/MENU** button to exit

All of the on screen displays will appear in the selected language

<b>FUNCTION</b>	
LANGUAGE	English
OSD Position	Mode 1
OSD Color	Mode 1
Melody	On
Wide	On
CCD	Off

◀ Move ± : Sel. ☐ : Prev.

## LCD MONITOR CONTROLS

### SYSTEM SETUP MENU: ON SCREEN MENUS AND DISPLAYS – OVERVIEW

Press the...

1. ...TV/MENU button to display the main system setup menu
2. ...CH ▲/▼ button to select sub-menus: Picture, Sound, Time, Function
3. ...VOL +/- to select and adjust an option

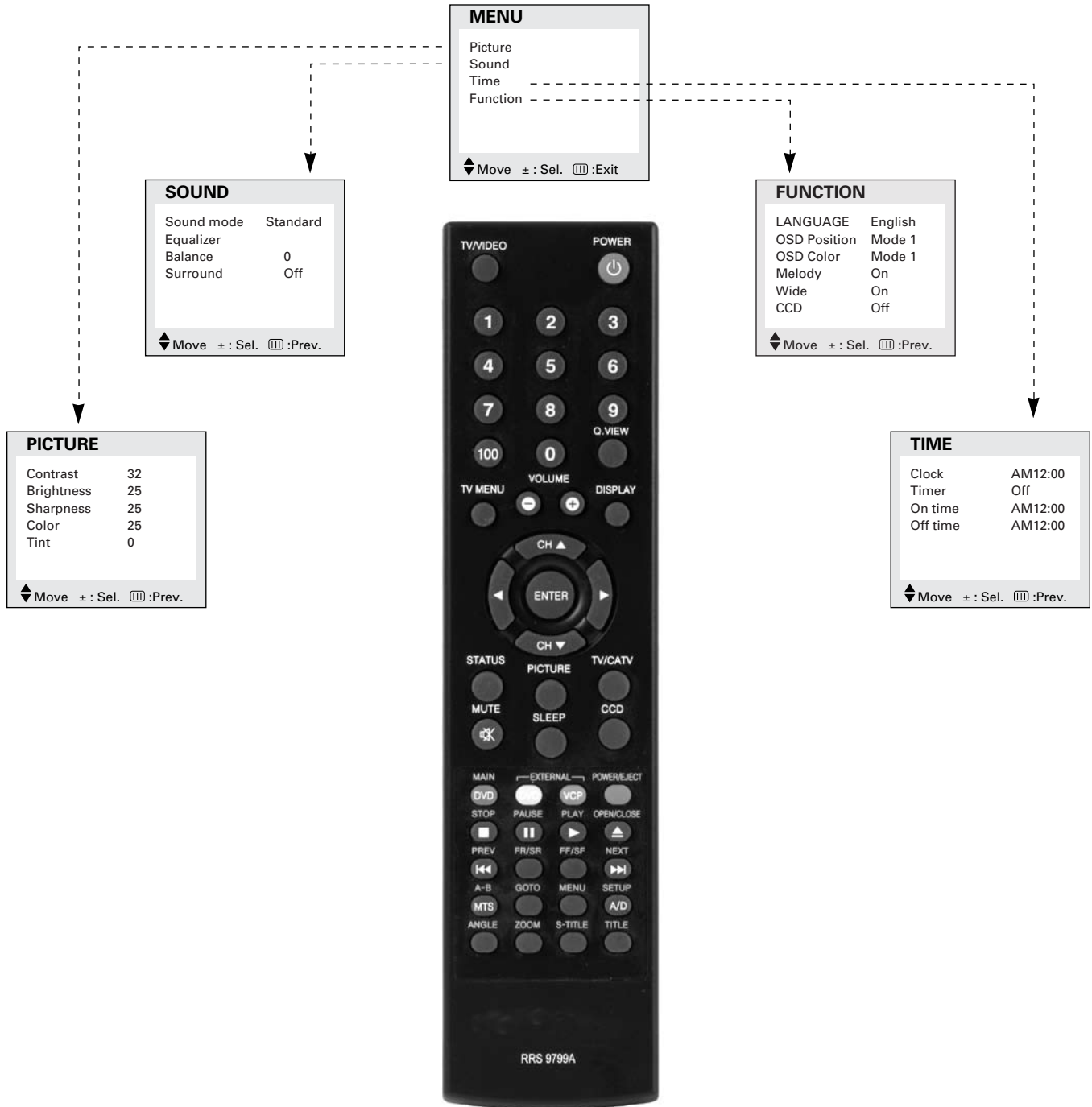

## MONITOR TUNER CONTROLS

### NORTH AMERICAN TUNERS

1. Power on/off
2. Selects broadcast input between Air/CATV
3. CH ▲/▼ to select TV channels
4. Press to scan TV channels into memory automatically
5. Press to select channel directly
6. +/- to add or erase channels from memory

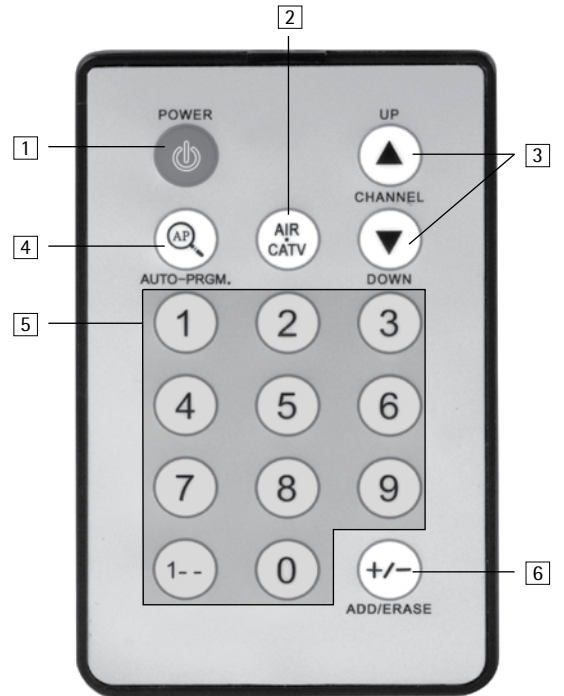

### EUROPEAN TUNERS

1. Power on/off
2. Menu: (AV mode only) Push to access on-screen menu.  
Use CH-/+ button to select item. Use VOL+/- button to adjust item.
3. Press AVC to select input mode: TV, AV1, AV2.
4. Press to scan channels into memory automatically
5. Press CH-/+ to select TV channels
6. Press Vol+/- to adjust sound level
7. Mute: sound on/off

Note: Volume and Mute buttons are disabled in AV mode.

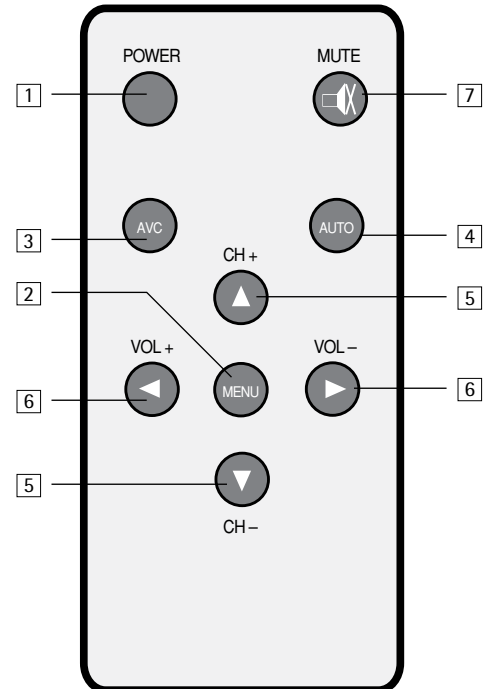

## HYDROPOOL OPTIONAL WATERPROOF REMOTE OVERVIEW

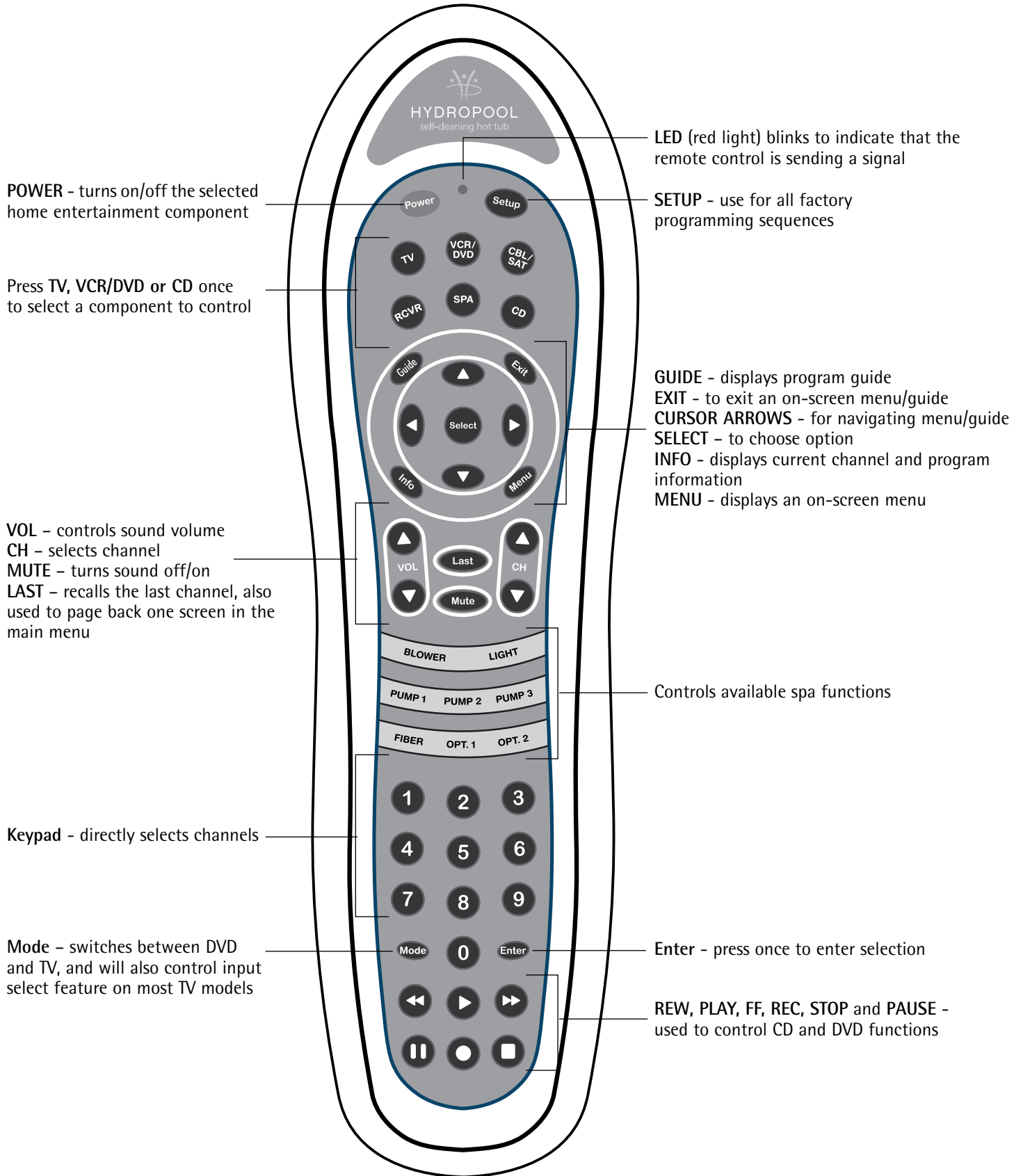

# HYDROPOOL AM/FM CD PLAYER OPTIONAL WATERPROOF REMOTE

## FUNCTION CROSS-REFERENCE

**STANDARD NON-WATERPROOF REMOTE (INCLUDED)**



**HYDROPOOL UNIVERSAL WATERPROOF REMOTE (OPTIONAL)**

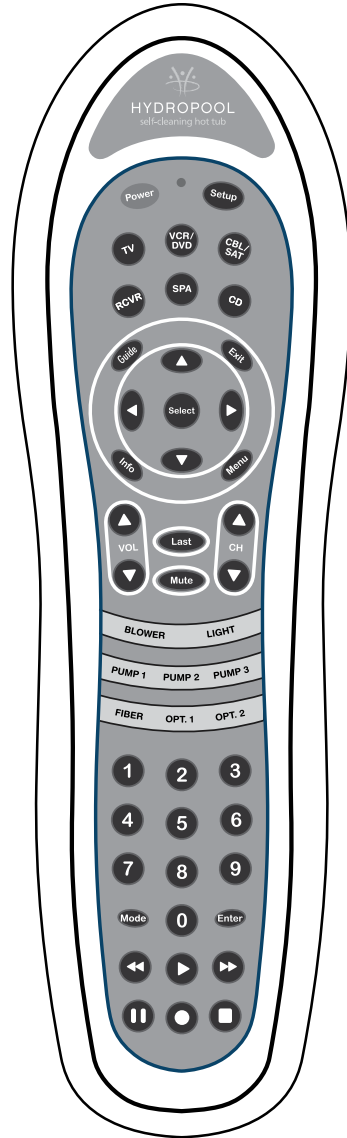

### FUNCTIONS

Power ON/OFF.....	CD + Power
Volume control.....	VOL ▲/▼
Mute.....	Mute
Source.....	Select
Band.....	Enter
Tune/seek up.....	FF ►►
Tune/seek down.....	REW ◄◄
Auto.....	Mode
CD repeat.....	Play ►
Audio.....	Record ●



# HYDROPOOL DVD PLAYER OPTIONAL WATERPROOF REMOTE

## FUNCTION CROSS-REFERENCE



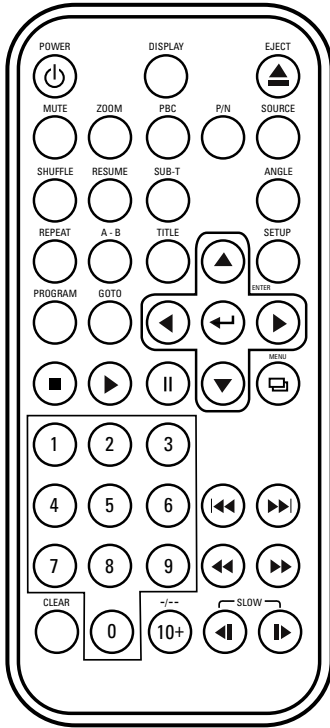



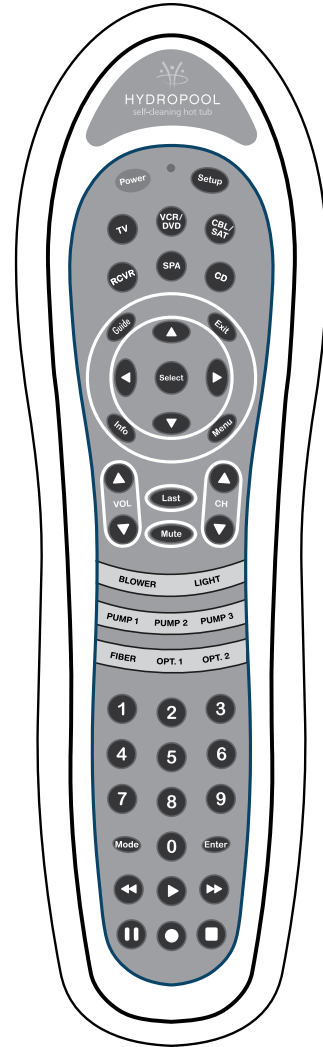

STANDARD NON-WATERPROOF REMOTE (INCLUDED)



HYDROPOOL UNIVERSAL WATERPROOF REMOTE (OPTIONAL)



### FUNCTIONS

Power .....	VCR/DVD + Power
Eject .....	Enter
Mute .....	Mute
Display .....	Info
Source .....	Mode
Setup .....	Exit
Menu .....	Menu
Cursor arrows .....	Cursor arrows 
Enter .....	Select
Play .....	Play 
Rapid FWD / BACK .....	FF  / REW 
Skip NEXT / PREV .....	CH  / 
Stop .....	Stop 
Pause .....	Pause 
Numbers 0 - 9 .....	Numbers 0 - 9

## HYDROPOOL LCD MONITOR OPTIONAL WATERPROOF REMOTE

### FUNCTION CROSS-REFERENCE

STANDARD NON-WATERPROOF REMOTE  
(INCLUDED)



HYDROPOOL UNIVERSAL WATERPROOF REMOTE  
(OPTIONAL)

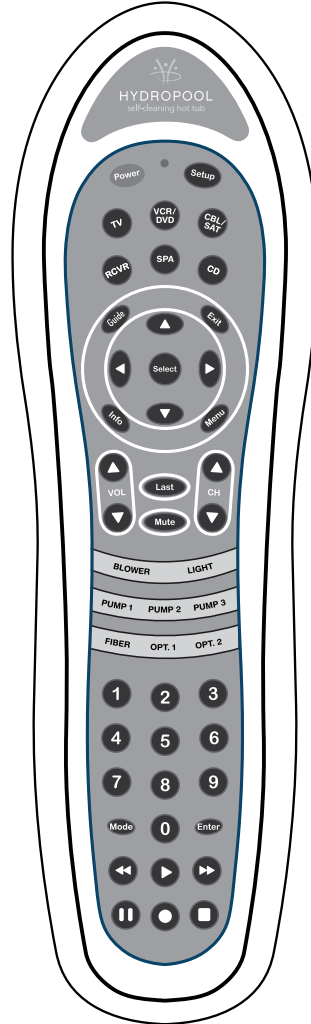

### FUNCTIONS

Power.....	TV + Power
Mute.....	Mute
Numbers 0 – 9 .....	Numbers 0 - 9
TV/AV .....	Mode
Menu .....	Menu
CH (channel UP/DN).....	CH ▲/▼
Menu navigation cursors.....	Cursor arrows 
Enter.....	Select
VOL (volume UP/DN) .....	VOL ▲/▼
Sleep.....	Record
CCD.....	Stop
Picture.....	Guide
Status.....	Exit
Display.....	Info

# HYDROPOOL MONITOR TUNER OPTIONAL WATERPROOF REMOTE

## FUNCTION CROSS-REFERENCE

STANDARD NON-WATERPROOF REMOTE  
(INCLUDED)

HYDROPOOL UNIVERSAL WATERPROOF REMOTE  
(OPTIONAL)

NORTH AMERICA



EUROPE

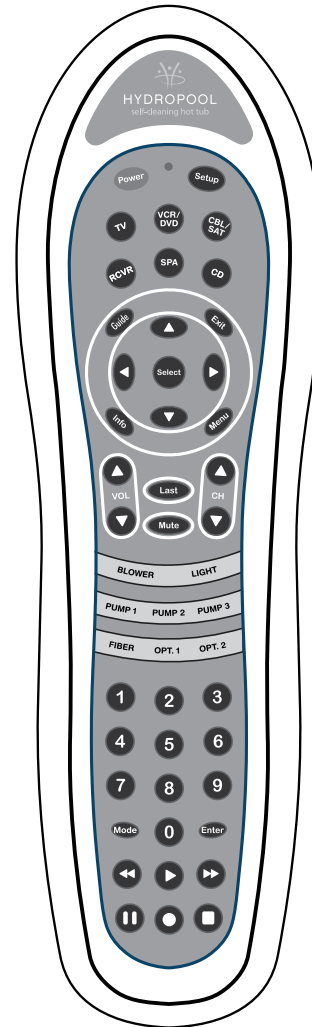
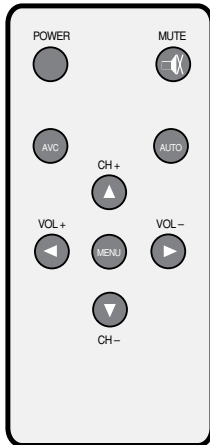

## FUNCTIONS

Power.....	CBL/SAT + Power
Mute (EU only) .....	Mute
Numbers 0 - 9 (NA only).....	Numbers 0 - 9
AIR/CATV (NA) / AVC (EU) .....	Mode
Auto-PRGM (NA) / Menu (EU) .....	Menu
CH (channel UP/DN).....	CH ▲/▼
Menu navigation cursors (EU only) .....	Cursor arrows 
Menu (EU only).....	Select
VOL (volume UP/DN) (EU only).....	VOL ▲/▼
Auto (EU only) .....	Guide
Add/Erase (NA only).....	Last

## HOT TUB WATER BALANCE – GENERAL OVERVIEW

### NOTABLE POINTS

- The reliability and longevity of your hot tub support equipment are directly related to how well water quality is maintained!
- The small volume of water in your hot tub is easily affected by the introduction of oils, lotions, perspiration and chemicals. It is imperative that you give your hot tub regular attention to maintain clean, safe and balanced water to prevent premature damage and/or failure (corrosion/calcification) to the support equipment. Maintaining proper hot tub water balance and sanitizer levels is extremely important. Neglected hot water will allow bacteria to quickly spread.
- The mineral content of hot tub water increases due to water evaporation, sanitizers and other chemicals. If the mineral concentration, particularly calcium, becomes too high, the minerals will literally "drop" or precipitate out of the water and deposit on the hot tub walls, plumbing, jets, in the filter and on the heater element.
- It is very important that pH be checked frequently and maintained in the recommended range as indicated in the chart WATER BALANCE SUMMARY FOR YOUR HOT TUB
- It is also very important that Total Alkalinity (the ability of the water to resist a change in pH) be maintained in the recommended range as indicated in the chart WATER BALANCE SUMMARY FOR YOUR HOT TUB
- Although there may be two identical hot tub models right next door to each other, the maintenance requirements will be different, dependant on such factors as:
  - bather load
  - frequency of use/quantity of bathers
  - different body chemistry
  - sun vs. shade
  - temperature

For these reasons, it is very important to develop proper hot tub water maintenance habits and follow your HydroPool retailer's recommended water maintenance procedures.



Heater and other component failure due to improperly maintained pH or Total Alkalinity is not covered under warranty.



### CHEMICAL HANDLING SAFETY HINTS

- Never pre-mix chemicals with each other prior to adding to hot tub water.
- Add only one chemical to the water at a time.
- Always add chemicals to water and not vice-versa.
- Chemicals may be corrosive, so handle with care and store in a cool dark place.
- Never smoke near chemicals as most are flammable
- Ensure any spilled chemicals are carefully cleaned up immediately.
- Always have the POISON CONTROL telephone number handy in the event of an emergency.
- Keep chemicals out of children's reach
- Wear safety glasses and gloves when handling chemicals.

### INITIAL WATER FILL & BALANCE

- 1 Make sure the hot tub water is circulating.
- 2 Add a sequesterant (stain and scale controller). Allow water to circulate for an hour before adding anything else to the hot tub water.
- 3 Add a Shock / oxidizing agent .
- 4 Add sanitizing tablets (Bromine or Chlorine) to the dispenser:

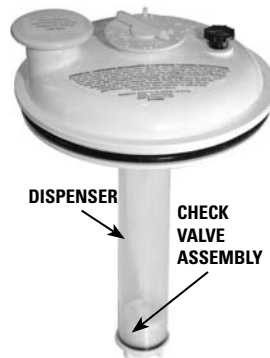

- Built in dispenser: if your HydroPool hot tub was ordered with the optional built in bromine/chlorine dispenser, (located in the lid of the cartridge filter housing), refer to section CARTRIDGE FILTER for details on removing and re-installing the lid. Once the filter lid is removed, you'll notice a clear 2.5 cm (1") diameter tube extending from the bottom of the lid.

Unscrew the check valve assembly at the end of the tube and add 5 or 6 tablets. Do not overfill dispenser as performance will be affected. Set the dial initially to '5', and allow water to circulate for 3 to 4 hours before testing level. Adjust dial more or less as necessary.

- Floating dispenser: As above, add 6 or 7 tablets, adjust initially to '5', allow water to circulate for 3 to 4 hours, then test.

The tablets will dissolve slowly over a 10-14 day period, depending on dial setting, and use of the hot tub.

- 5 Test pH and Total Alkalinity and adjust accordingly.

## GLOSSARY OF COMMON WATER MAINTENANCE TERMS

- 1 **CHLORINE** – in granular, liquid or puck/tablet form, is an oxidant and biocidal agent. It is very effective and fast acting. Recommended chlorine residual level is 3.0 to 5.0 ppm.
- 2 **CHLORAMINES** – a compound formed when chlorine combines with nitrogen or ammonia present in the water. When allowed to go unchecked, it causes eye and skin irritation and is indicated by a strong chlorine odour.
- 3 **ONE-PART BROMINE** – also available in puck/tablet form, is another type of oxidant/biocidal agent, and is introduced into the hot tub water via a brominator. Recommended bromine residual level is 3.0 to 5.0 ppm
- 4 **TWO-PART BROMINE** – composed of a liquid or powder component introduced manually into the water on a weekly basis, and a granular component that is added daily or as the hot tub is used.
- 5 **BROMAMINES** – are formed when bromine destroys nitrogen-bearing organic matter. Unlike chloramines, bromamines don't cause eye irritation, however, when allowed to go unchecked, will cause an objectionable odour.
- 6 **SHOCK** – the practice of adding an oxidizing agent to hot tub water to destroy ammonia, nitrogenous and organic contaminants (chloramines and bromamines)
- 7 **pH** – a logarithmic value expressing the relative acidity or basicity of a substance (such as hot tub water) as indicated by the hydrogen ion concentration. pH is expressed as a number on a scale of 0 to 14, where 0 is most acidic, 1 to 7 being acidic, 7 considered neutral, 7 to 14 being basic, and 14 being most basic. The ideal range for hot tub water is 7.4 to 7.6 ppm
- 8 **pH INCREASER** – raises the pH level of the water.
- 9 **pH DECREASER** – lowers the pH level of the water.
- 10 **TOTAL ALKALINITY (TA)** – the amount of carbonate, bicarbonate and hydroxide compounds present in the water that determines the ability or capacity of the water to resist change in pH. Also known as the 'buffering' capacity.
- 11 **ALKALINITY BOOSTER** – raises the alkalinity.
- 12 **CALCIUM HARDNESS** – the calcium portion of the total alkalinity which represents 70 to 75% of total hardness. Calcium concentrations determine whether water is 'soft' – too little calcium, or 'hard' – too much calcium.
- 13 **CALCIUM BOOSTER** – increases the calcium level.
- 14 **TOTAL DISSOLVED SOLIDS (TDS)** – a measure of the total amount of dissolved matter in the water (calcium, carbonates, bicarbonates, magnesium, metallic compounds, etc.)
- 15 **SEQUESTERANTS (STAIN AND SCALE CONTROLLERS)** – keeps dissolved metals and minerals in the water from attacking the hot tub shell and support equipment components.
- 16 **DEFOAMER** – removes foam build-up from the water surface. At best, this is a temporary remedy, as excessive foam is merely a symptom of improper water balance (typically high organic residue and/or high pH).
- 17 **CARTRIDGE FILTER CLEANER** – degreases and cleans cartridge filters.
- 18 **OZONATOR** – generates Ozone (a gaseous molecule composed of 3 atoms of oxygen) and is injected into the hot tub water for the oxidation of water contaminants.
- 19 **TEST KIT** – used to monitor specific chemical residual or demands in the water. May be in the form of litmus strips or liquid drops.
- 20 **PPM** – abbreviation for 'parts per million', the unit of measurement used in chemical testing which indicates the parts by weight in relation to one million parts by weight of water. Essentially identical to the term mg/L – milligrams per liter.

### WATER BALANCE SUMMARY FOR YOUR HOT TUB\*

SANITIZER (ppm)	MIN	IDEAL	MAX
Chlorine	1.0	3.0 - 5.0	10.0
Bromine	2.0	3.0 - 5.0	10.0
<b>CHEMICAL</b>			
PH	7.2	7.4 - 7.6	7.8
Total Alkalinity (TA)	80	80 - 120	180
Total Dissolved Solids (TDS)	300	1000 - 2000	3000
Calcium Hardness	150	200 - 400	500 - 1000

\* National Spa & Pool Institute recommended levels for residential spas/hot tubs

## WATER BALANCE TROUBLESHOOTING

PROBLEM	POSSIBLE CAUSES	SOLUTIONS
cloudy water	microscopic particles too small to filter out	Test and adjust all water balance elements and add flocculent* to cause the particles to combine together so they can be filtered out
	high Total Alkalinity	Test these water balance elements and adjust to recommended parameters.
	high pH levels	
	high Calcium Hardness	
scale (white/grayish deposit)	high Calcium Hardness	Test calcium hardness level and treat with sequestering agent* or perform partial drain/refill.
skin/eye irritation	improper pH and/or Total Alkalinity levels	Test water balance and make the appropriate adjustments.
excessive foam	buildup of body oils or cosmetics	If no water line is present you can try using defoamer* to break up the contaminants and then a clarifier* to help filter them away. If a water line is present the spa may need to be drained and cleaned. Either way, the filter should be thoroughly cleaned by soaking over night in bleach. An oil absorbing sponge can help in preventing this in the future.
	Laundry detergent residual in swimwear	Prevent by running an extra rinse cycle on washing machine or re-rinse well by hand.
	excess organic contaminants	Some organic matter is prone to causing foamy water as it breaks down in the filter (maple leaves especially). Generally using defoamer* to break up the contaminants, then a clarifier* to help filter them away followed by thoroughly cleaning your filter will clear up the problem. It may however be necessary to drain and refill your spa if the foaming is quite excessive.
	low Calcium Hardness	Test calcium hardness and if necessary increase with calcium chloride*
corrosion/etching	low Calcium Hardness and/or low Total Alkalinity	Test calcium hardness and if necessary increase with calcium Chloride*
discoloured water (clear v. turbid water)	presence of metals in water (iron, copper, etc)	Treat with chelating* or sequestering agent*
unstable pH	low Total Alkalinity levels	Test total alkalinity levels and if necessary increase with sodium bicarbonate*
pH resistant to changing	high Total Alkalinity levels	Test total alkalinity levels and if necessary decrease with sodium bisulfate* or muriatic acid*

\* contact your local Hydropool retailer for specific product recommendation



## CORONA DISCHARGE OZONE TECHNOLOGY

All HydroPool hot tubs are factory prepared to accommodate ozonators. The HydroPool Corona Discharge Ozonator is regarded as the most technologically advanced system on the market, allowing longer contact time with the hot tub water resulting in reduced chemical consumption and clearer, cleaner water. HydroPool's unique ozone injection system both maximizes the dispersion of the ozone gas and decreases the bubble size resulting in longer contact with the water and increased water quality and purity. The ozone/water mixture is sent down a series of tubes where the ozone is "broken down" into even smaller bubbles before being re-mixed with the water reducing the "off-gassing" commonly found with other ozone systems.

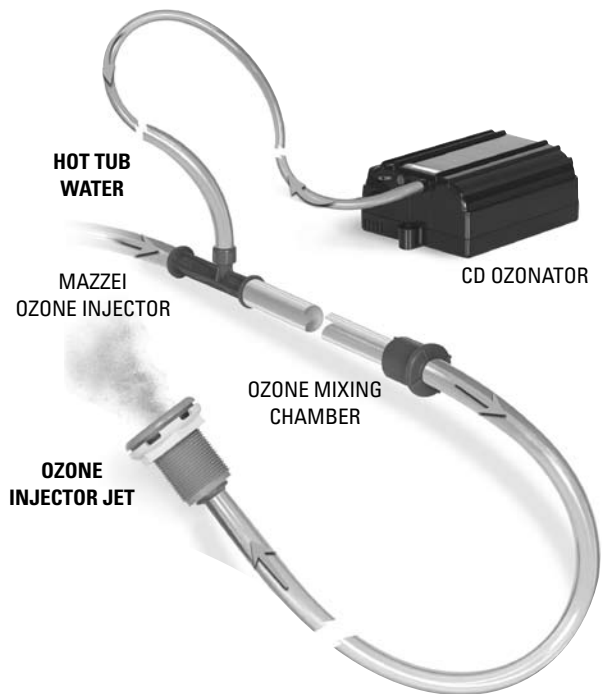

## ROUTINE HOT TUB MAINTENANCE



### REVIEW CHEMICAL HANDLING SAFETY HINTS

#### DAILY

- 1 Test water, and if necessary, add shock.
- 2 Ensure proper water level is maintained.

#### WEEKLY

- 1 Test pH and Alkalinity. Adjust accordingly
- 2 Top-up chemical dispenser
- 3 Add sequesterant (stain and scale controller)
- 4 Remove and spray cartridge filter with garden hose and re-install (see section CARTRIDGE FILTER)
- 5 Remove and clean out skimmer basket (see section CLEANING THE SKIMMER BASKET)
- 6 Add Shock / oxidizing agent
- 7 Inspect union connections for o-ring and gasket leaks - Tighten if loose

#### MONTHLY

- 1 Soak your filter cartridge in a filter cartridge cleaning solution. Rinse thoroughly and, if possible, allow to dry before re-installing. HydroPool recommends purchasing a second filter so that while the first is cleaning, the other is clean and ready to install

#### QUARTERLY

- 1 Drain hot tub at least once per quarter and clean the acrylic shell surface with a non-abrasive cleaner designed specifically for acrylic surfaces. See sections CHANGING THE HOT TUB WATER and DRAINING YOUR HOT TUB

#### CLEANING THE SKIMMER BASKET

- 1 Activate the STANDBY/DRAIN ASSIST mode
- 2 Remove the skimmer basket by pulling the weir door forward, and pulling the basket up and towards the front
- 3 Remove debris from basket. (Note: Avoid hitting the basket against objects to knock debris loose as this may damage the unit)
- 4 Reinsert basket
- 5 Take the system out of STANDBY/DRAIN ASSIST mode, and as the pump begins to operate, monitor water flow over the weir door to assure that it is free floating



## CARTRIDGE FILTER

The cartridge should be cleaned every two to four weeks, depending on the amount of use. Signs that the filter requires cleaning include:

- Reduced jet power
- Hazy gray water
- Rattling noise in the pump or filter
- Heater not working

### REMOVAL

- 1 Activate the STANDBY/DRAIN ASSIST mode.
- 2 Remove the filter cover and open the small, black air vent/bleeder valve on the top of the filter lid.
- 3 Press down the lock tab to disengage and turn the locking ring counter clockwise.
- 4 Pull the filter lid upwards, and lift the cartridge element straight up and out of filter housing.

### CLEANING

- 5 With a garden hose and spray nozzle, hose off the cartridge element, ensuring to carefully separate every pleat.
- 6 To remove collected lotions, body oils, etc. soak the cartridge in warm water and a filter cleaning/emulsifying compound (available at your HYDROPOOL retailer).
- 7 A cleaning cylinder may be purchased from your HYDROPOOL Hot tub retailer.
- 8 Rinse thoroughly and dry before replacing.
- 9 Hydopool recomends purchasing a spare filter cartridge so that you always have a clean substitute ready to rotate.
- 10 After the element has dried - if necessary, lightly brush between pleats with a fine paint-brush to remove remaining dirt particles.



Do not use a wire brush or other devise to clean cartridge element. Do not put in dishwasher or washing machine.

### RE-INSTALLATION

- 11 Place the cartridge filter back into the filter housing.
- 12 Replace the filter housing lid, pushing it down to seat, ensuring that the lid o-ring does not become twisted.
- 13 Hydopool recomends that the lid o-ring be lubricated with a non-petroleum based lubricant (ie. Silicone gel) when it becomes dry. This will help to prevent twisting and pinching as the lid is installed, and significantly increase longevity of the o-ring.
- 14 Install the filter lock-ring, turning clockwise until the lock tab snaps into place.
- 15 Close the air vent/bleeder valve.
- 16 Take the system out of STANDBY/DRAIN ASSIST mode.
- 17 When the pump starts circulating on low speed, it will be necessary to release trapped air in the filter. Carefully loosen the air vent/bleeder valve counter-clockwise until there is the hissing sound of air escaping. Once there is a steady stream of water, close the vent valve, ensuring that the o-ring does not become pinched.

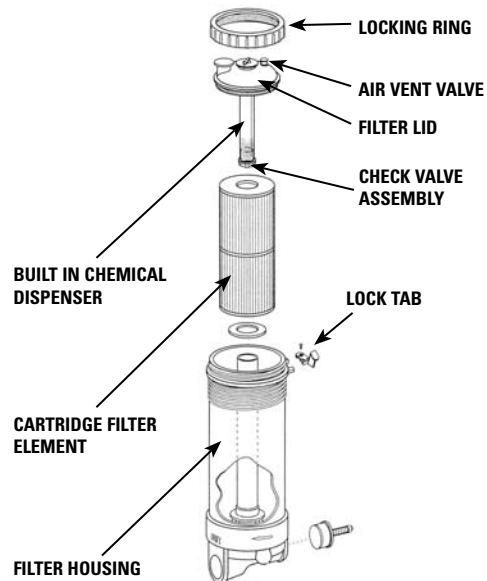

## CLEANING THE ACRYLIC SURFACE

The acrylic surface can be cleaned and polished using a soft cloth and acrylic cleaner, available at your Hydopool retailer.



- **Important: Do not use detergents** - the remaining residues will adversely affect water chemistry, making it difficult to maintain proper water balance
- **Do Not use abrasive cleaners** - damage to the acrylic surface will occur.

## SAFETY HARD COVER

When a hot tub is uncovered, over 90% of heat is lost from the water surface. This evaporation also affects the chemical balance and could create humidity problems indoors. HYDROPOOL Safety Hard Covers are engineered for maximum thermal efficiency and appearance. They are hinged in the middle for easier handling, and the zip fastener allows the tapered foam inserts to be changed if damaged. The skirt of the safety hard cover hugs the lip of the hot tub for a tight fit. The handles are placed so that even one person can easily carry a large cover. The locks, with one part fastened to the deck or skirt, prevent small children or animals from entering the hot tub. Do not drag the safety hard cover across the hot tub or decking. Fold the cover first, then lift by the handles. Standing on the hardcover could cause the tapered foam inserts to crack, which will lead to water absorption.

### NEVER LEAN OR STAND ON YOUR HARDCOVER.

The cover should be cleaned at least twice a year with a vinyl moisturizer and protector.

## CHANGING THE HOT TUB WATER

A hot tub should be drained every 8-12 weeks, depending on size and amount of use. If your hot tub is used daily or by a large number of bathers, the water should be drained more often. One method to determine the approximate length of time between water changes is to divide the water volume (in liters) of your hot tub by 13.5 and then divide by the average number of bathers each day.

$$\text{Formula } \left( \frac{\text{Volume of water in litres}}{13.5} \right) \div \left( \frac{\text{Average daily bathers}}{\text{Days between water changes}} \right) = \left( \frac{\text{Days between water changes}}{\text{Average daily bathers}} \right)$$

### EXAMPLE:

1000 liters divided by 13.5 divided by 2 = 37 days.

The hot tub water must be changed when the amount of dissolved solids becomes excessive, and is usually indicated by "gray" or dull looking water.

## DRAINING YOUR HOT TUB HYDROPOOL EXCLUSIVE QUICK-DRAIN™ & FILL REFER TO DIAGRAM

### OVERVIEW

- Requires the use of 2 garden hoses - drain hose and fill hose
- While first garden hose is draining old water from hot tub...
- ...second hose is used to wash down interior surface of the hot tub and for fresh water fill.

### REFER TO FIGURE 1 & FIGURE 2

- 1 Locate nearest drain facility (shower, laundry tub, floor drain, lawn, etc.).
- 2 Put the hot tub control system into STANDBY/DRAIN ASSIST mode. The system will automatically exit Standby Mode after 1 hour and resume normal operating functions.
- 3 Remove the skimmer basket so that the hole beneath it is accessible, and insert the #10 rubber expansion plug provided.
- 4 Attach garden hose to hose bib located on plumbing line beside the hot tub control system.
- 5 Run garden hose to drain location.
- 6 Open hose bib.
- 7 Close pump1 return gate valve next to the hose bib (this directs the water out the drain hose).
- 8 Activate the low speed pump.
- 9 Monitor the hot tub while it drains.
- 10 Use the second garden hose to wash down interior surface as the hot tub continues to drain. A sponge may also be used to wipe down the interior surface.

- 11 To completely flush the old water from the plumbing lines: allow fresh water to fill into the foot-well area while the old water continues to be pumped out. Always keep at least 10cm (4 in.) of water in the foot-well so that pump 1 remains primed.
- 12 When the water from the drain hose turns clear (indicating fresh fill water), flush is complete.
- 13 Turn OFF the low speed pump.
- 14 Close the drain-hose bib on the hot tub plumbing line and continue filling hot tub with fresh water.
- 15 Place cover on hot tub (to avoid splash-out).
- 16 Open pump 1 return gate valve.
- 17 Press any button on the topside control panel (other than the pump 1 button) to take the system out of STANDBY/DRAIN ASSIST mode. Pump 1 low speed and the heater will activate to circulate and heat the water while filling continues. This also reduces the possibility of an airlock occurring.
- 18 Continue adding fresh fill water until level is approximately 19mm (3/4 in.) from the top of the skimmer opening.
- 19 Once fill is complete, remove the #10 rubber expansion plug from the bottom of the skimmer housing.\*
- 20 If the filter housing was opened to replace the cartridge filter, it will be necessary to release trapped air from the filter housing by carefully loosening the small black air vent/bleeder valve located on the top of the filter housing. When water begins to escape close the air vent valve.
- 21 In the unlikely event of a pump air lock (pump 1 is operating but there is no water movement from the jets), refer to section PUMP PRIMING/RELEASING AN AIR LOCK

\* It may be necessary to put system into STANDBY/DRAIN ASSIST mode in order to remove plug.

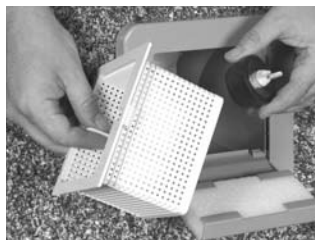

FIGURE 1

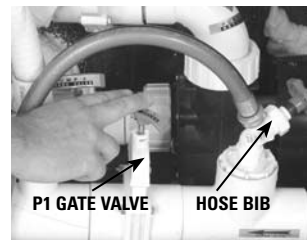
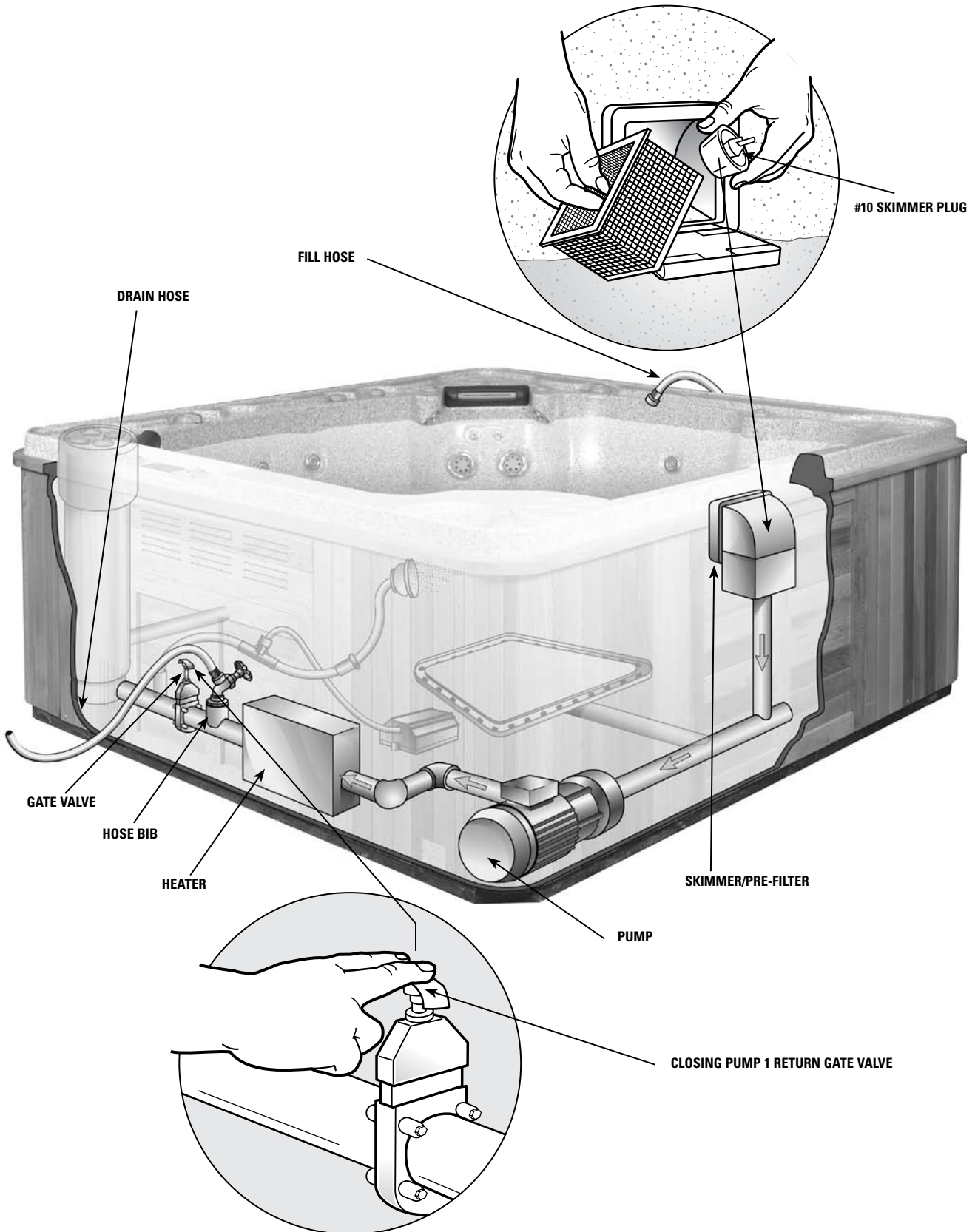

FIGURE 2

## WATER SOFTENERS

Never fill a hot tub with water from a water softener, as it could adversely effect the water chemistry, making it difficult to maintain proper water balance. If you live in an area with hard or soft water, give careful attention to your Calcium Hardness level. Topping up with soft water is acceptable.

## HYDROPOOL EXCLUSIVE QUICK-DRAIN™ & FILL



## CABINET WING-LOCKS

The high quality wing-locks provided on your Hydropool Hot Tub cabinet not only firmly secure the equipment access panel, they also serve as convenient handles for removal and replacement. In order to maintain optimum performance and extended life, Hydropool recommends lubricating twice annually with a silicone based lubricant.

**RECOMMENDED PRODUCT:** Super-Lube silicone based lubricant (or equivalent). Available at major retailers.



**CAUTION:** Do not use a petroleum based lubricant, as this will cause premature deterioration of the lock seal.



## PROTECTING YOUR CABINET WOOD FINISH

HYDROPOOL hot tub cabinets are made from Western cedar and are factory stained. Once stained, cedar weathers well, and with proper care will maintain its beauty for many years. For a protective translucent finish and to enhance the wood grain beauty use Sikkens Cetol 01 #077

stain or equivalent. A polyurethane or marine varathane with UV inhibitors is also highly recommended. These protective finishes stabilize the wood grain and build a durable, breathable water-repellent barrier between the wood surface and the elements. These products are available from your local building supply center.

## GAZEBOS

If you are mounting, or planning to mount a gazebo over the top of your hot tub, it is critical to ensure that Hydropool is aware of this, as extra supports may be necessary. Otherwise, it will be necessary for your installer to add the extra supports where required.





## WINTERIZING YOUR HYDROPOOL HOT TUB

In the event that you do not wish to use your hot tub year-round, it is very important that you properly winterize to protect against damage from freezing. Your HYDROPOOL retailer can perform this service for a nominal fee. If you choose to winterize your hot tub yourself, please follow the directions outlined below:

- Drain the hot tub entirely see section - DRAINING YOUR HOT TUB
- Remove and clean the cartridge filter element see section - CARTRIDGE FILTER
- Using a wet/dry utility vacuum, remove remaining water from the jet openings, filter cartridge housing, and footwell.
- Either pour or use a turkey-baster where necessary to add potable biodegradable RV antifreeze to areas such as pump wet end, jet channels, filter housing, blower channels. **DO NOT USE AUTOMOTIVE ANTIFREEZE.**
- **Important: mixing potable biodegradable RV antifreeze with water significantly reduces its ability to protect against freezing. Therefore, it is very important ALL water is removed from the hot tub plumbing before adding.**
- Add potable RV antifreeze to the holes in the bottom suction/drain to prevent any trapped water in the false floor from freezing and damaging the hot tub shell.
- Turn pump on for only a few seconds to circulate the antifreeze.
- Unthread and disconnect all unions in the support equipment area. Remove lowest winter drain plug on pump face plate. Repeat for all pumps, where applicable.

- Cover exposed plumbing connections with plastic bags and duct tape.
- Where practical, disconnect hot tub support equipment and store in a dry heated area.
- Install the safety hardcover, and cover the entire hot tub with a tarp to prevent premature weathering of the cabinet and the safety hard cover.
- Remove snow build up regularly to prevent damage to the safety hard cover.
- It is assumed that your HYDROPOOL hot tub has been properly installed on a reinforced concrete pad to eliminate lifting of the hot tub due to hydrostatic ground water pressure.



If you are not 100% confident that your hot tub is properly winterized, please consult your authorized HYDROPOOL Hot Tub Retailer. Caution recommends that an authorized Hydropol Retailer winterize your hot tub in the initial year. Damage as a result of freezing is not covered by the warranty.

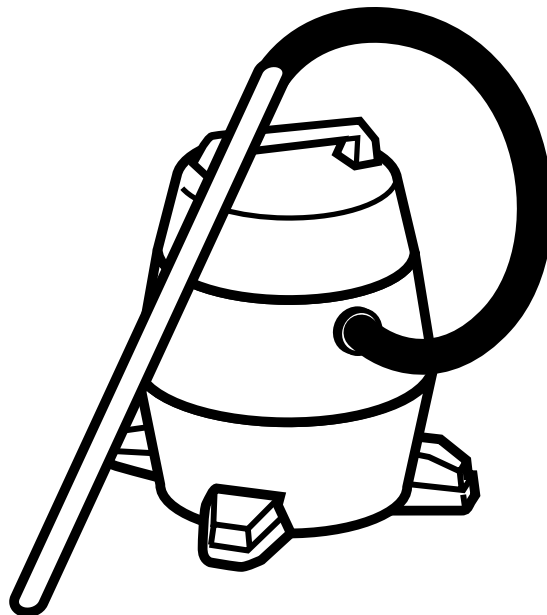
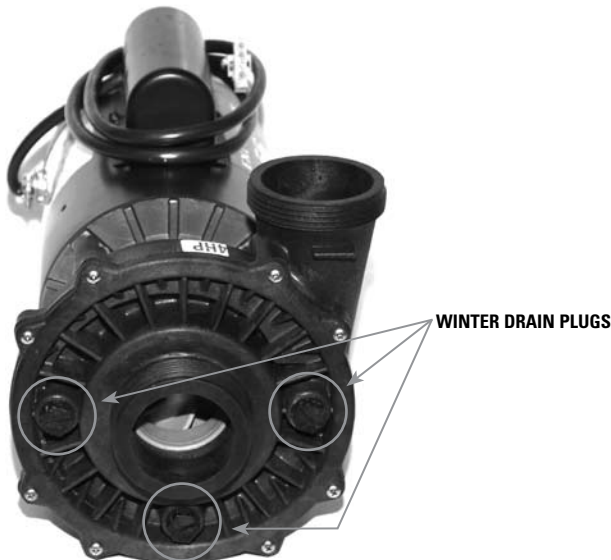



## GENERAL TROUBLESHOOTING

### ELECTRICAL/MECHANICAL

SYMPTOM	POSSIBLE REASON(S)	ACTION
No Power	<ul style="list-style-type: none"> <li>- Breaker off at main panel or fuse out</li> <li>- Improper wiring</li> <li>- Fuse blown in control</li> <li>- G.F.C.I. tripped</li> </ul>	<ul style="list-style-type: none"> <li>- Verify that breaker and/or GFCI are on</li> <li>- If there is still no power, contact your HydroPool retailer or a qualified electrician</li> </ul>
G.F.C.I. Trip	<ul style="list-style-type: none"> <li>- Short or ground in system</li> <li>- Faulty G.F.C.I.</li> </ul>	<ul style="list-style-type: none"> <li>- As above-contact qualified electrician or your HydroPool retailer</li> </ul>
No Circulation	<ul style="list-style-type: none"> <li>- Pump is not primed (air lock)</li> <li>- Gate valves are closed</li> <li>- Water level is too low</li> <li>- Skimmer obstructed or closed</li> </ul>	<ul style="list-style-type: none"> <li>- See PUMP PRIMING/RELEASE AN AIR LOCK</li> <li>- Open gate valves</li> <li>- Top up water to proper level</li> <li>- See CLEANING SKIMMER BASKET</li> </ul>
Jet Surge	<ul style="list-style-type: none"> <li>- Water level too low</li> <li>- Blockage in plumbing lines</li> <li>- Suction gate valve partially closed</li> </ul>	<ul style="list-style-type: none"> <li>- Add water to correct level</li> <li>- Check gate valves and/or skimmer basket</li> <li>- Pull gate valve handle "up" all the way</li> </ul>
No Heat or Erratic Heat	<ul style="list-style-type: none"> <li>- Cartridge filter requires cleaning</li> <li>- Blockage in plumbing line</li> <li>- Suction / Return valve partially closed</li> <li>- low water level</li> <li>- Faulty sensor</li> </ul>	<ul style="list-style-type: none"> <li>- Clean &amp; reinstall</li> <li>- Contact your HydroPool retailer</li> <li>- Ensure valves are open</li> <li>- Top up water level</li> <li>- Contact your HydroPool retailer</li> </ul>
Noisy Motor	<ul style="list-style-type: none"> <li>- Damaged or worn bearings</li> <li>- Low voltage</li> <li>- Low water level</li> <li>- Frozen pump</li> </ul>	<ul style="list-style-type: none"> <li>- Contact your HydroPool retailer or a qualified electrician</li> <li>- Contact qualified electrician</li> <li>- Top up water level</li> <li>- Thaw out</li> </ul>
Digital Top Side No Longer Displays	<ul style="list-style-type: none"> <li>- Improper connection</li> <li>- Electrical brown-out</li> </ul>	<ul style="list-style-type: none"> <li>- Contact your HydroPool retailer</li> <li>- Reset GFCI OFF/ON</li> </ul>
Digital Temperature Display is Erratic or Flashing	<ul style="list-style-type: none"> <li>- Water temperature has exceeded set point</li> </ul>	<ul style="list-style-type: none"> <li>- Decrease filter cycle and or add cold water.</li> <li>- If condition continues contact HydroPool retailer</li> </ul>

## **GENERAL TROUBLESHOOTING CONTINUED**

### **WHAT TO DO IN THE EVENT OF...**

#### **...POWER FLUCTUATIONS**

The power supply into your home is, for the most part, fairly consistent. However, when local power demand is high, there is a tendency for the voltage entering your home to drop (sometimes significantly) or fluctuate. This condition is referred to as a 'brown-out'. Although safeguards have been built into the system to protect against this condition, supply voltage may drop low enough, if even for a second, to cause the system to display a 'ghost' message. Should this occur or if the display shows partial messages, try resetting the system by turning power to the hot tub off, waiting a few minutes, then turning power on again. If this does not reset the system, contact your local HydroPool retailer or service organization.

#### **...POWER FAILURE OR SYSTEM FAULT DURING COLD WEATHER CONDITIONS**

If your control system will not reset, (ie. GFCI trips) or if your pump will not circulate for any other reason, place a low wattage space heater under the cabinet in the equipment area. This will delay the risk of freezing while a service appointment is scheduled.



Always follow the manufacturers instructions when locating and placing a portable electric space heater into service. Ensure that safe clearance to combustible surfaces is maintained. Do not leave unattended.

### **NOTES:**

**NOTES:**